

# Инструменты и аксессуары

## Технические характеристики

По вопросам продаж и поддержки обращайтесь:

Алматы (727)345-47-04  
Ангарск (3955)60-70-56  
Архангельск (8182)63-90-72  
Астрахань (8512)99-46-04  
Барнаул (3852)73-04-60  
Белгород (4722)40-23-64  
Благовещенск (4162)22-76-07  
Брянск (4832)59-03-52  
Владивосток (423)249-28-31  
Владикавказ (8672)28-90-48  
Владимир (4922)49-43-18  
Волгоград (844)278-03-48  
Вологда (8172)26-41-59  
Воронеж (473)204-51-73  
Екатеринбург (343)384-55-89

Иваново (4932)77-34-06  
Ижевск (3412)26-03-58  
Иркутск (395)279-98-46  
Казань (843)206-01-48  
Калининград (4012)72-03-81  
Калуга (4842)92-23-67  
Кемерово (3842)65-04-62  
Киров (8332)68-02-04  
Коломна (4966)23-41-49  
Кострома (4942)77-07-48  
Краснодар (861)203-40-90  
Красноярск (391)204-63-61  
Курск (4712)77-13-04  
Курган (3522)50-90-47  
Липецк (4742)52-20-81

Магнитогорск (3519)55-03-13  
Москва (495)268-04-70  
Мурманск (8152)59-64-93  
Набережные Челны (8552)20-53-41  
Нижний Новгород (831)429-08-12  
Новокузнецк (3843)20-46-81  
Ноябрьск (3496)41-32-12  
Новосибирск (383)227-86-73  
Омск (3812)21-46-40  
Орел (4862)44-53-42  
Оренбург (3532)37-68-04  
Пенза (8412)22-31-16  
Петрозаводск (8142)55-98-37  
Псков (8112)59-10-37  
Пермь (342)205-81-47

Ростов-на-Дону (863)308-18-15  
Рязань (4912)46-61-64  
Самара (846)206-03-16  
Санкт-Петербург (812)309-46-40  
Саратов (845)249-38-78  
Севастополь (8692)22-31-93  
Саранск (8342)22-96-24  
Симферополь (3652)67-13-56  
Смоленск (4812)29-41-54  
Сочи (862)225-72-31  
Ставрополь (8652)20-65-13  
Сургут (3462)77-98-35  
Сыктывкар (8212)25-95-17  
Тамбов (4752)50-40-97  
Тверь (4822)63-31-35

Тольятти (8482)63-91-07  
Томск (3822)98-41-53  
Тула (4872)33-79-87  
Тюмень (3452)66-21-18  
Ульяновск (8422)24-23-59  
Улан-Удэ (3012)59-97-51  
Уфа (347)229-48-12  
Хабаровск (4212)92-98-04  
Чебоксары (8352)28-53-07  
Челябинск (351)202-03-61  
Череповец (8202)49-02-64  
Чита (3022)38-34-83  
Якутск (4112)23-90-97  
Ярославль (4852)69-52-93

Россия +7(495)268-04-70

Казахстан +7(727)345-47-04

Беларусь +(375)257-127-884

Узбекистан +998(71)205-18-59

Киргизия +996(312)96-26-47

эл.почта: [wes@nt-rt.ru](mailto:wes@nt-rt.ru) || сайт: <https://wood-stone.nt-rt.ru/>



Wood Stone tools are designed for efficient kitchen operation, and to help you get the most out of your oven. With a few exceptions, most tools feature heavy-duty stainless steel handles and grease-resistant grips—built for years of dependable service.

**A. LOADING PEELS** WS-TL-LP-(S, M, L or XL)

These lightweight aluminum alloy Loading Peels come in five sizes that are perfect for up to 12", 14", 16" and 18" pizzas. A 13" loading peel is available in stainless steel.

**B. NATURAL FIBER BRUSH**

WS-TL-NFB-(S, M, L or XL)

For general sweeping, we offer a Natural Fiber Brush. The short and medium lengths have wood handles (pictured below). The long and extra long lengths have stainless steel handles and replaceable heads.

**C. IN-LINE BRASS-BRISTLED BRUSH**

WS-TL-IFB-(S, M, L or XL)

The heavy-duty In-Line Brush features a 10" wood head, beveled to facilitate debris removal from all corners of the oven. In-Line brush heads are replaceable.

**D. T-STYLE BRASS-BRISTLED BRUSH**

WS-TL-TFB-(S, M, L or XL)

**E. T-STYLE NATURAL FIBER BRUSH**

WS-TL-TNFB-(S, M, L or XL)

The heavy-duty T-Style Brush features a 10" wood head, beveled to facilitate debris removal from all corners of the oven. T-Style brush heads are replaceable.

**F. BUBBLE HOOK** WS-TL-BH-(S, M, L or XL)

The Bubble Hook is for popping pizza dough bubbles before they get out of hand. Made from heavy gauge stainless steel, it is also great for moving pans, trays and even wood.

**G. UTILITY PEEL** WS-TL-UP-(S, M, L or XL)

Move or rotate any size pizza with nearly surgical precision with Wood Stone's Utility Peel. The 8-inch diameter utility peel is also very useful for moving pans, placing wood on the fire and removing ash. Select lengths available in either stainless steel or titanium versions.

**H. PARTICLE SHOVEL** WS-TL-PS-(S, M, L or XL)

Our heavy gauge stainless steel Particle Shovel is designed to safely remove ash and coals from wood-fired ovens and charbroilers. The head and handle are welded to ensure durability. Its front is beveled to remove ash from even hard-to-reach corners.

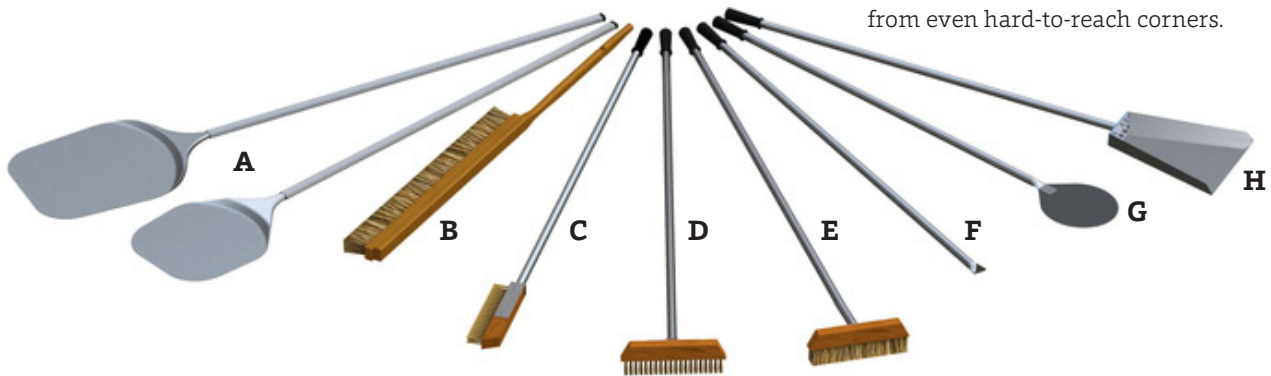

WHAT LENGTH IS RIGHT FOR YOUR OVEN?	Oven Model	Short (S)	Medium (M)	Long (L)	X-Long (XL)
	Bistro Line	3030, 4343, 4836	4355		
	Mountain Series		Mt. Adams 5', Mt. Chuckanut 4'	Mt. Baker 6'	Mt. Rainier 7'
	Fire Deck Series		6045, 8645, 9660, 11260	11275	9690, 11290
	Traditional Series		5'	6'	
	Designer Series		6348, 7248		



Brush Sets	Item #	Nat'l Fiber	In-Line Brush	T-Style Brush
Short Brush Set	WS-TL-BS-S	36"	40"	40"
Medium Brush Set	WS-TL-BS-M	51"	60"	60"
Long Brush Set	WS-TL-BS-L	70"	70"	70"
Extra Long Brush Set	WS-TL-BS-XL	87"	87"	87"

Gas-Fired Oven Tool Sets	Item #	T-style Nat'l Fiber Brush	Nat'l Fiber Brush	In-Line Brush	T-Style Brush	Bubble Hook	Utility Peel S/S
Short Gas Tool Set	WS-TL-SET-GAS-S	N/A	36"	40"	40"	40"	40"
Medium Gas Tool Set	WS-TL-SET-GAS-M	60"	51"	60"	60"	60"	60"
Long Gas Tool Set	WS-TL-SET-GAS-L	70"	70"	70"	70"	70"	70"
Extra Long Gas Tool Set	WS-TL-SET-GAS-XL	87"	87"	87"	87"	87"	87"

Wood-Fired Oven Tool Sets	Item #	T-style Nat'l Fiber Brush	Nat'l Fiber Brush	In-Line Brush	T-Style Brush	Bubble Hook	Utility Peel S/S	Particle Shovel
Short Wood Tool Set	WS-TL-SET-WOOD-S	N/A	36"	40"	40"	40"	40"	40"
Medium Wood Tool Set	WS-TL-SET-WOOD-M	60"	51"	60"	60"	60"	60"	60"
Long Wood Tool Set	WS-TL-SET-WOOD-L	70"	70"	70"	70"	70"	70"	70"
Extra Long Wood Tool Set	WS-TL-SET-WOOD-XL	87"	87"	87"	87"	87"	87"	87"

Key	Individual Tools	Part #	Short (-S)	Medium (-M)	Long (-L)	X-Long (-XL)
<b>A</b>	12" Loading Peel	WS-TL-LP-12-*	32"	50"	60"	87"
<b>A</b>	13" Loading Peel †	WS-TL-LP-13-*	32"	50"	60"	87"
<b>A</b>	14" Loading Peel	WS-TL-LP-14-*	32"	50"	60"	87"
<b>A</b>	16" Loading Peel	WS-TL-LP-16-*	N/A	50"	60"	87"
<b>A</b>	18" Loading Peel	WS-TL-LP-18-*	N/A	50"	60"	87"
<b>B</b>	Natural Fiber Brush ††	WS-TL-NFB-*	36"	51"	70"	87"
<b>C</b>	In-Line Brass-Bristled Brush	WS-TL-IFB-*	40"	60"	70"	87"
<b>D</b>	T-Style Brass-Bristled Brush	WS-TL-TFB-*	40"	60"	70"	87"
<b>E</b>	T-Style Natural Fiber Brush	WS-TL-TNFB-*	40"	60"	70"	87"
<b>F</b>	Bubble Hook	WS-TL-BH-*	40"	60"	70"	87"
<b>G</b>	Utility Peel-Stainless	WS-TL-UP-*	40"	60"	70"	87"
<b>H</b>	Utility Peel-Titanium	WS-TL-UP-T-*	40"	60"	70"	87"
<b>I</b>	Particle Shovel	WS-TL-PS-*	40"	60"	70"	87"

\* Complete the part number with the length character code, either S, M, L or XL.

† 13" Loading Peel is stainless steel. All other peels are aluminum.

†† Short & Medium lengths have wood handles; Long and Extra Long have stainless steel handles and heads are replaceable.



Wood Stone tools shown have heavy-duty stainless handles and grease-resistant grips.

## A. SCRAPER TOOL

The Scraper Tool is useful for scraping the deck floor and removing heavy, baked-on debris and buildup. A stainless steel handle, grease-resistant grip and angled head provide plenty of leverage, even in the rear of the oven.

WS-TL-S-60 Small/Medium Handle, 60"

WS-TL-S-70 Long Handle, 70"

WS-TL-S-80 Extra Long Handle, 80"

## B. PITA PEEL WS-TL-PP-63

The 63" basket-style Pita Peel is designed for scooping up multiple pitas, finishing them in the dome (without overheating) and removing them. No other tool can perform these functions as well. The handle is stainless steel, and the basket is sturdy, lightweight aluminum.

## C. FLOOR TOUCH-UP TOOL WS-TL-TU

The 67" Floor Touch-Up Tool provides a means to smooth minor surface irregularities on the oven deck, especially when a slightly uneven surface has developed due to a crack in the oven deck.

## D. COAL OVEN RAKE

The triangular hoe-style Coal Oven Rake is useful in coal-fired ovens for manipulating coal inside the oven chamber, as well as scraping debris and fly ash through the coal grates and into the ash chute.

Available in two lengths:

WS-TL-CR-M Medium Handle, 63"

WS-TL-CR-XL Extra Long Handle, 84"

## E. TOOL GRIP 3000-0005

Replacement grease-resistant Tool Grip for any stainless steel handled Wood Stone oven tool. Minimum order of two.

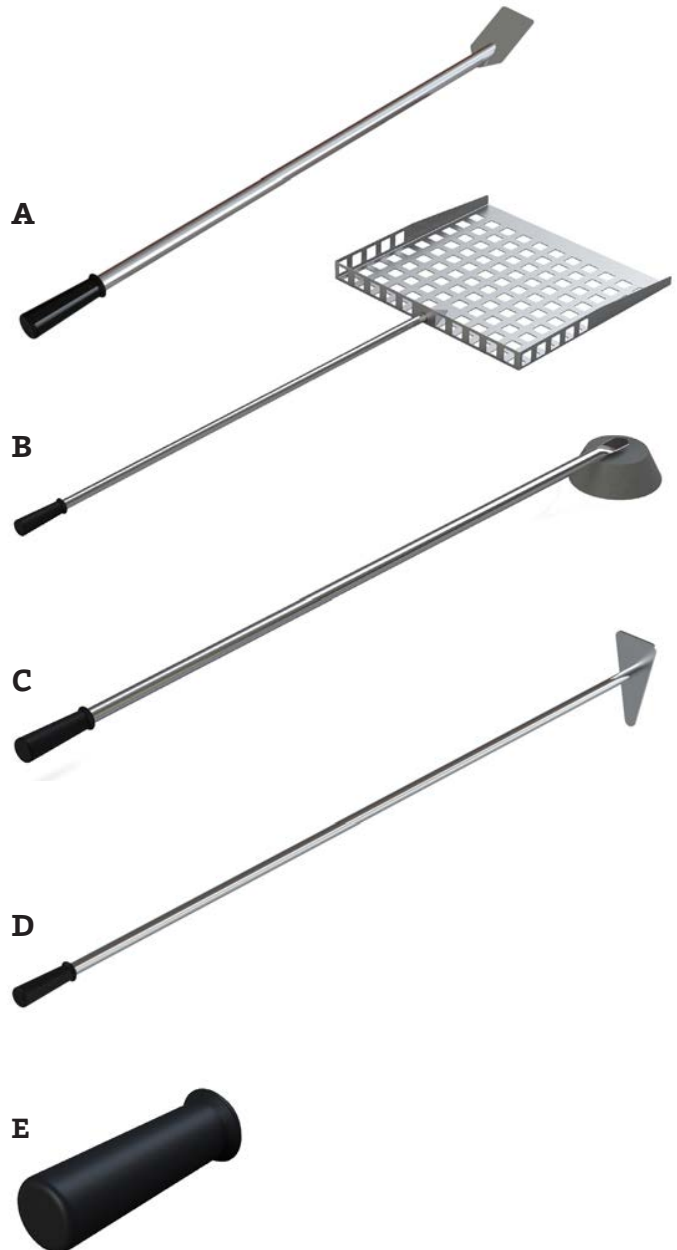



### F. DETACHABLE PEEL HANDLE WS-TL-DPH

The 38" stainless steel Detachable Peel Handle has been designed to securely attach and quickly release Detachable Peel Heads (3000-0058). When the peel head is inserted into the catch, the latch automatically locks it in place. Peels are removed by pressing the latch.

### G. DETACHABLE PEEL HEAD 3000-0058

These 18 x 26" wood Detachable Peel Heads with 7" handle (minimum order of 6) have been designed to securely attach and quickly release using the Detachable Peel Handle (WS-TL-DPH, sold separately). Pizzas built on detachable peels are ready for immediate baking or can be pre-staged, ready for the rush!

### H. IN-LINE OR T-STYLE BRASS-BRISTLED BRUSH REPLACEMENT HEAD 3000-0002

Replacement Head for both In-Line and T-Style Brass-Bristled Brushes. By orienting the 10" brush head differently, the same head works for both styles of brush. Minimum order of two.

### I. T-STYLE NATURAL FIBER BRUSH REPLACEMENT HEAD 3000-0060

Replacement Head for the T-Style Natural Fiber Brush. Minimum order of two.

### J. NATURAL FIBER BRUSH REPLACEMENT HEAD 3000-0037

Replacement Head for the Long and Extra Long Natural Fiber Brush. Minimum order of two.

**Note:** Short and Medium lengths are single piece construction, so the head alone is not replaceable.

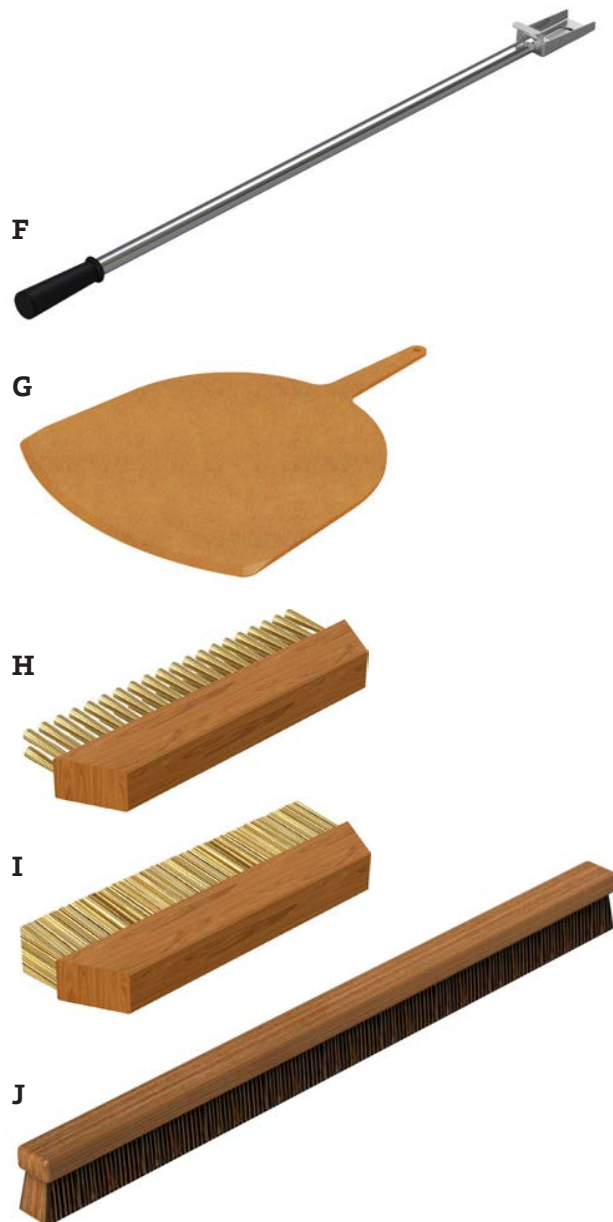

**A. HIGH-TEMP CERAMIC BAKING SLATE**

The heart of a Wood Stone oven is now available for your conventional rack or convection oven—Baking Slates manufactured from the same ceramic used in the construction of our stone hearth ovens. The slates are cast into standard sheet pans so they are conveniently sized at 18 x 26", weighing 44 lbs (full sheet) and 18 x 13", weighing 18 lbs (half sheet).

In addition to enhancing the crust properties of pizza and bread products, the high-temperature Ceramic Baking Slate will help the oven hold on to valuable heat that is normally lost every time the door is opened.

WS-SLATE-1826 (full sheet)

WS-SLATE-1813 (half sheet)

**B. HAND HELD IR THERMOMETER WS-TL-IRT**

This easy-to-use device allows instant surface temperature measurements anywhere in your Wood Stone oven. Just point the Hand Held IR Thermometer at the surface in question and press the button—the temperature is instantly displayed on an LCD readout. The button can be held down for scanning surfaces. The meter takes a reading every half second and has accuracy of  $\pm 3$  °F and a range of 0–750 °F. It is powered by one 9V battery and is built of high-impact plastic for long life.

**A****B**



### C. SMOKER BOX 000-313

Wood Stone's Smoker Box uses wood chips to give the aroma of a wood-fired oven in a gas-fired oven. Constructed of heavy-duty stainless steel for years of service. The box is 9.5" long x 4.25" wide x 2" deep.

### D. OVEN TOOL HANGER 1650118

Wood Stone's Oven Tool Hanger offers a convenient way to have your tools easily accessible while cooking. The hanger is 2.5" wide x 3.5" deep. Minimum order of two.

### E. LOADING PEEL TOOL HANGER

3000-0054

The Loading Peel Tool Hanger is specifically designed to accommodate all loading peels. The hanger is 4.5" wide x 1.625" deep. Minimum order of two.

### F. DEBRIS MANTEL

000-10-001

Wood Stone's new patent-pending Debris Mantel is designed for easy crumb and debris collection. Keep your burners clear by collecting debris in conveniently removable trays. Slide the trays out for easy emptying and wash them in any standard commercial dishwasher.

C



D

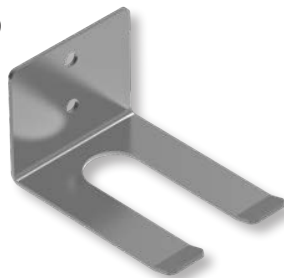

E



F

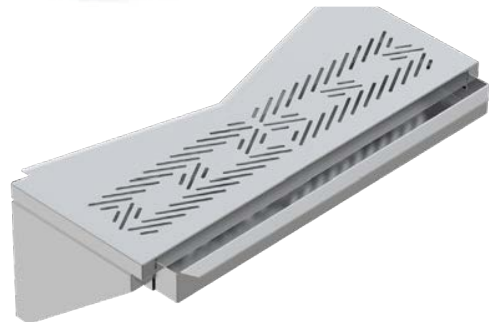

Oven Tool Hanger and Loading Peel Tool Hanger in use at Devon Energy Headquarters, Oklahoma City, OK.



**A. BROILER SHELVES**

Add another level to your Fire Deck or Mountain Series ovens (5-7')! Wood Stone's new Broiler Shelves are designed to quickly add additional space inside your oven. Position the shelves flush with the back wall and cook food at approximately 100° F temp higher than the floor!

MS-5 Single Shelf Kit

MS-5 Dual Shelf Kit

MS-6 Single Shelf Kit

MS-6 Dual Shelf Kit

MS-7 Single Shelf Kit

MS-7 Dual Shelf Kit

FD-6045

FD-8645

FD-8645-DF

FD-9660

FD-9660-DF

FD-11260

FD-11260-DF

**A**



MS-5 Single Shelf Kit

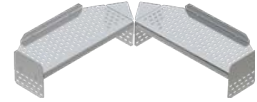

MS-5 Dual Shelf Kit



MS-6 Single Shelf Kit

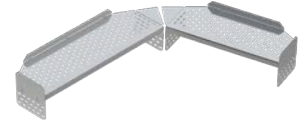

MS-6 Dual Shelf Kit



MS-7 Single Shelf Kit

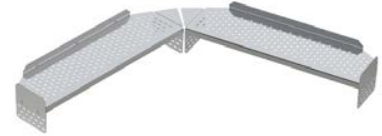

MS-7 Dual Shelf Kit



FD-6045

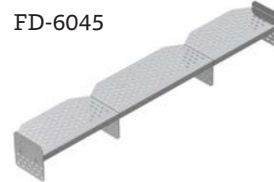

FD-8645



FD-9660

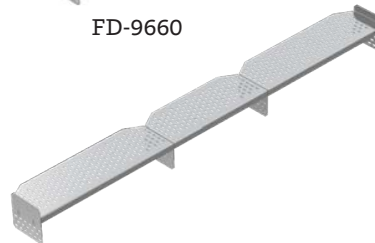

FD-11260



FD-8645-DF

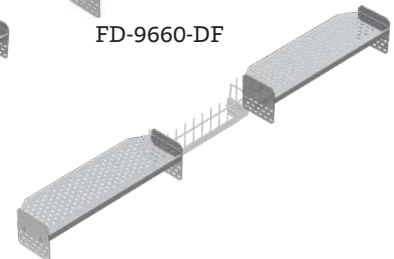

FD-9660-DF



FD-11260-DF



### NIGHT HEAT RETENTION DOORS

Conserve the heat of your oven overnight using Night Heat Retention Doors. They are constructed of stainless steel, with spring handles. **Note:** These doors should not be used when the oven is turned on.

#### A. BISTRO LINE OVENS

000-3030-ND (for Model WS-BL-3030)

000-4343-ND (for Models WS-BL-4343, BL-4355, BL-4836)

#### B. MOUNTAIN SERIES OVENS

000-4-ND (for Model WS-MS-4)

000-5-ND-SET (for Model WS-MS-5)\*

000-6-ND-SET (for Model WS-MS-6)\*

000-7-ND-SET (for Model WS-MS-7)\*

#### C. FIRE DECK SERIES OVENS

000-9660-ND-SET (for Models WS-FD-9660, FD-11260)\*

000-9690-ND-SET (for Models WS-FD-9690, FD-11275,  
FD-11290)\*

000-90112-ND-SET (for Model WS-CS-90-112)\*

000-8645-ND-SET (for Model WS-FD-8645)\*\*

000-6045-ND-SET (for Model WS-FD-6045)\*

\*Item consists of a two-door set

\*\*Item consists of a three-door set

**A**



000-4343-ND shown.

**B**

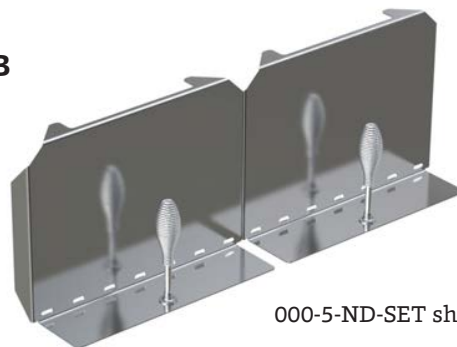

000-5-ND-SET shown.

**C**

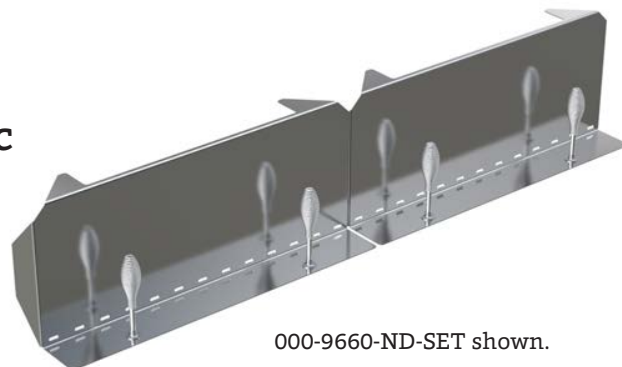

000-9660-ND-SET shown.



**A. TANDOOR NAAN HOOK WS-TL-SK-HOOK**

The 37" Tandoor Naan Hook is used in conjunction with the Tandoor Naan Scraper for the traditional preparation of Naan bread, allowing efficient removal of multiple loaves. This handcrafted stainless steel tool is built to last.

**B. TANDOOR NAAN SCRAPER WS-TL-SK-SCRAPER**

The 37" Tandoor Naan Scraper is used in conjunction with the Tandoor Naan Hook to remove Naan bread in the traditional method. Handcrafted by Wood Stone.

**C. TANDOOR SKEWER (SEEKH) WS-TL-SK**

The 37" Tandoor Skewer is designed for vegetables and proteins. The stainless steel skewer includes two Keeper Clips (000-318-CLIP).

**D. TANDOOR NAANDLE WS-TL-NAANDLE**

The 34" Tandoor Naandle replicates a traditional Naan pillow. The pillow covers a spring-loaded aluminum plate with a stainless steel handle and grease-resistant grip to allow for easy application of the Naan bread to the interior walls of the Tandoor.

**E. TANDOOR 9" CANVAS COVER & PAD 3000-0017**

Replacement Canvas Cover & Pad for the Tandoor Naandle.

**F. TANDOOR SKEWER INDEXING RING**

The Tandoor Skewer Indexing Ring, standard with new Tandoors, sits atop the opening to support skewers. Replacements available for both 31" and 35" models.

1650810 (for 31" Tandoor)

1650809 (for 35" Tandoor)

**G. TOOL SET FOR TANDOOR WS-TL-SET-TANDOOR**

The Tool Set For Tandoor includes one Tandoor Naan Hook (WS-TL-SK-HOOK), one Tandoor Naan Scraper (WS-TK-SK-SCRAPER) and 10 Tandoor Skewers (WS-TL-SK).

**H. SAUCE PAN RACK 000-402-57**

A stainless steel shelf with cutouts for a 1/9th pan, a 1/6th pan and a 2.5 qt. round pan (pans/lids included) which hang from posts on either side of the square Tandoor.

**I. STAINLESS STEEL SHELF 000-401-57**

A high quality, stainless steel work shelf which hangs from posts on either side of the square Tandoor.

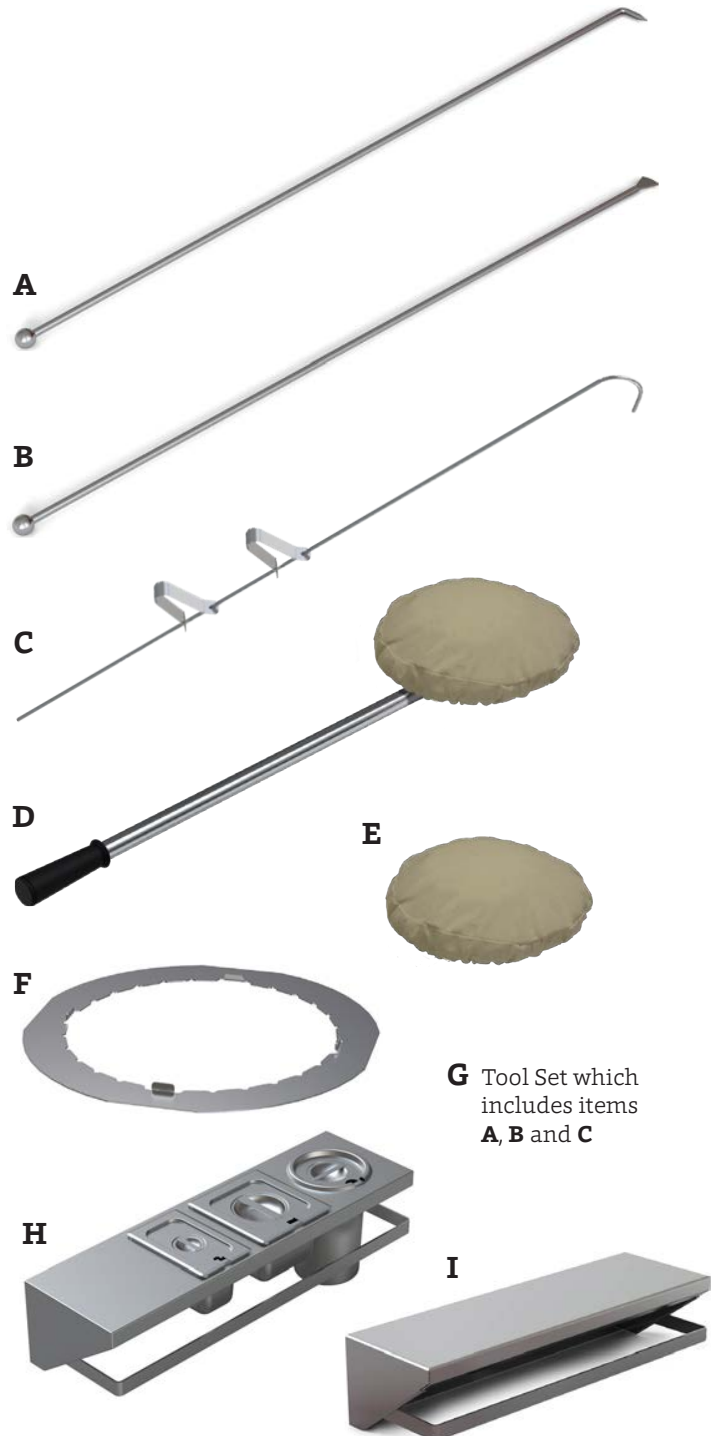

**G** Tool Set which includes items **A, B** and **C**



### A. BROILER SHELF

000-BROILER-SHELF-(34, 45, 54, 57 or 72)

Adjustable stainless steel Broiler Shelf with Wire Cooking Racks for grilling, roasting, or smoking. Not available with rotisserie-equipped units. In 34", 45", 54", 57" or 72" widths.

### B. SKEWER (SATAY) RACK

000-SKEWER-RACK-(34, 45, 54)

Stainless steel Skewer (Satay) Rack perfect for satay, kabobs or skewers. In 34", 45", 54", 57" or 72" widths. There is space for 1 rack, 2 racks, 2 racks, 3 racks, and 3 racks, respectively.

### C. SACRIFICIAL HEAT SHIELD 000-403-(34, 45, 54, 57)

Protects the back wall of the broiler from dents and dings

### D. SAUCEPAN RACK 000-402-(29, 34, 45 or 57)

A high-quality, stainless steel shelf with cutouts for one 1/9th pan (except -34), one 1/6th pan, and one 2.5 qt. round pan (pans with lids included). **Note:** One (-45) rack can be mounted on either side, and two racks will fit on the front of all charbroiler models, except the SFB-5426.

Two (-29) racks can fit on the front of the SFB-5426.

Three (-45) pan racks can fit on the front of the SFB-72.

### E. STAINLESS STEEL SHELF

000-401-(29, 34, 45 or 57)

A high-quality, stainless steel work shelf with an under-slung utensil rail for hanging tongs or other grill tools.

**Note:** One (-45) Stainless Steel Shelf can be mounted on either side, and two shelves will fit on the front of all charbroiler models, except the SFB-5426.

Two (-29) shelves can fit on the front of the SFB-5426.

Three (-45) shelves can fit on the SFB-72.

### F. GRATE TOOL WS-TL-GT

A durable, stainless steel tool with a hook for moving grill grates, the Grate Tool is also useful for manipulating the firebox and wood inside of the charbroiler.

### G. PARTICLE SHOVEL WS-TL-PS-S

Our 40" heavy gauge stainless steel Particle Shovel is designed to safely remove ash and coals from the Mt. St. Helens Charbroiler. Its front is beveled to remove ash from even hard-to-reach corners.

### H. T-STYLE BRASS-BRISTLED BRUSH

WS-TL-TFB-S

The 40" T-Style Brass-Bristled Brush is used to brush off Broiler Grates. Replacement Heads are available (see pg 7).

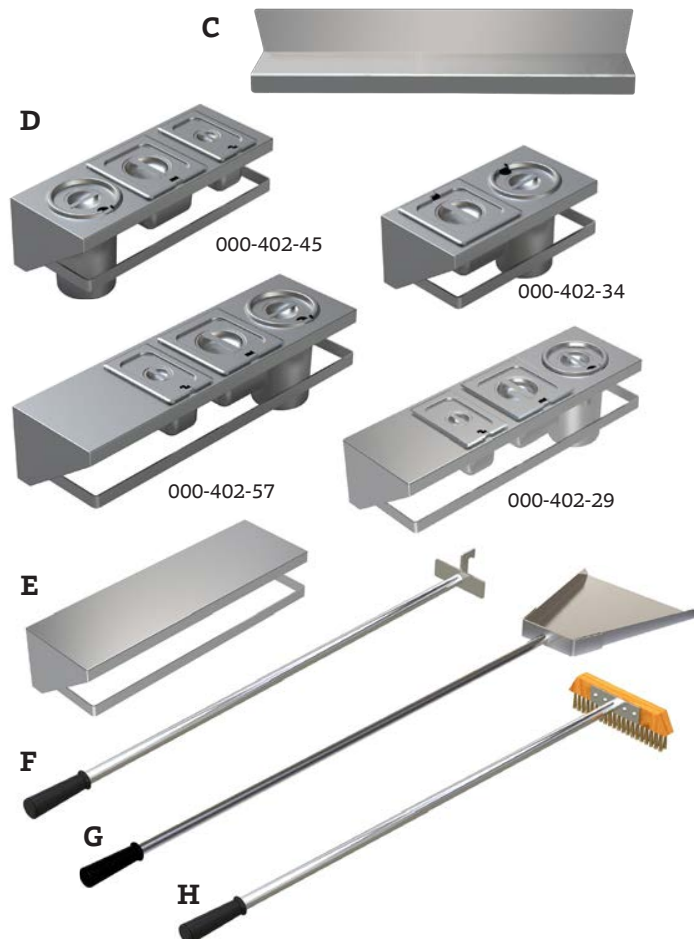



**A. STANDARD BROILER GRATE 50RO-0017**

Replacement 6 x 24" Standard Broiler Grate for the 34", 45", 57" and 72" Mt. St. Helens Charbroiler. **Note:** Two grates on the 72" model are 4 x 24" grates (50RO-0017-1). See table below.

**B. MODEL 5426 BROILER GRATE 50RO-0017-2**

Replacement 6 x 16" broiler grate for model SFB-5426 of the Mt. St. Helens Charbroiler. See table below.

**C. BROILER GRATE NARROW 50RO-0017-1**

Replacement 4 x 24" broiler grate for the 72" model. **Note:** The 72" model also utilizes 6 x 24" Standard Broiler Grates (50RO-0017). See table below.

Model	6 x 24" Grates (A)	6 x 16" Grates (B)	4 x 24" Grates (C)
SFB-34	5		
SFB-45	7		
SFB-57	9		
SFB-72	10		2
SFB-5426		8	

*Countertop model grate requirements are identical.*

**D. BROILER SHELF WIRE COOKING RACKS 000-404**

Replacement 10 x 10.75" wire cooking racks for the Broiler Shelf.

SFB-34 (6 racks total)

SFB-45 (8 racks total)

SFB-5426, SFB-57 (10 racks total)

**E. SEARING PLATE 000-SEARING-PLATE**

Replace a 6 x 24" Standard Broiler Grate with a Searing Plate to sear scallops, sauté chopped veggies or even make pancakes! Made of polished mild steel. Not available for the SFB-5426.

**F. HEAT SHIELD**

000-403-(34, 45, 54, 57 or 72)

The high quality, stainless steel Heat Shield, available for all Mt. St. Helens models, serves as a heat guard and backsplash to protect a wall at the rear of the charbroiler, adding 20" to the height of the charbroiler.

**Note:** When the optional Okanogan Single-Spit Rotisserie, which has its own rear shroud, is installed on the Mt. St. Helens Charbroiler, this Heat Shield is not compatible.

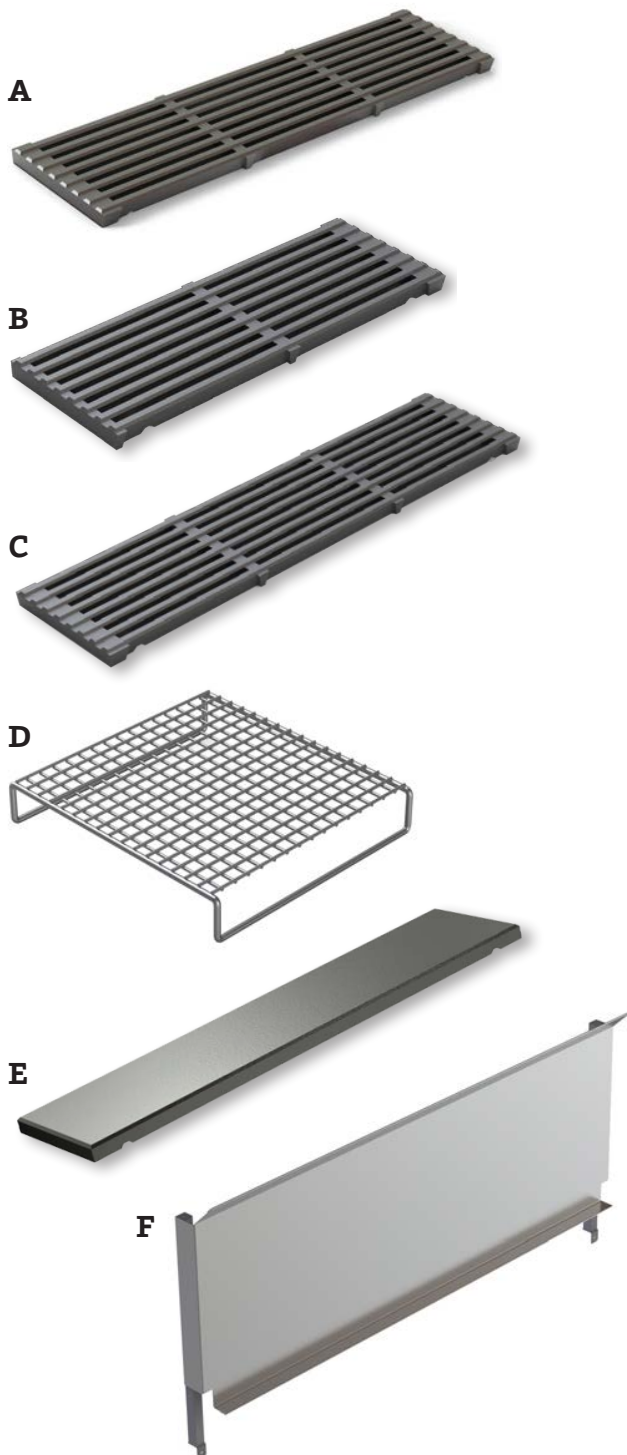



### A. STANDARD ANGLE SPIT 000-307

The Standard Angle Spit is included with all Wood Stone rotisseries. Six to seven average-sized birds can be quickly loaded. The perforations are convenient for securing the string or skewers used to bind the legs.

### B. SQUARE SPIT WITH ADJUSTABLE FORKS 000-306

The Square Spit With Adjustable Forks is made of half-inch square stock stainless steel and comes with 5 double forks and two single forks. It is easy to load and the forks hold the birds in place so that no binding of the legs is required. This spit holds from 1 to 6 birds of various sizes and is ideal for larger products like turkeys.

### C. CLAMSHELL BASKET 000-300

The versatile Clamshell Basket spit is constructed of heavy gauge stainless steel and conveniently adjusts to hold a variety of products, ranging from fresh vegetables to two entire prime ribs. Stainless steel screens are also available to help secure smaller items. Includes Chain Assembly For Clamshell Basket locking mechanism.

### D. FISH AND VEGETABLE SCREEN 000-305

The 26 x 16" Fish And Vegetable Screen inserted into the Clamshell Basket compartment expands the versatility of the spit.

### E. RIB/FISH BASKET SPIT

The Rib/Fish Basket Spit is available in a 3-arm, 6 compartment, or in a 4-arm, 8 compartment model. On the 4-arm spit, each compartment is suitable for a full rack of ribs, a sizeable salmon fillet or several smaller cuts of meat. On the 3-arm spit, the size of each compartment makes it ideal for larger items such as tri-tip roasts and pork loins. The laser-cut containment flap is spring-loaded for easy loading and unloading.

000-311-(R, L) 3-arm, 6 compartment

000-303-(4R, 4L) 4-arm, 8 compartment

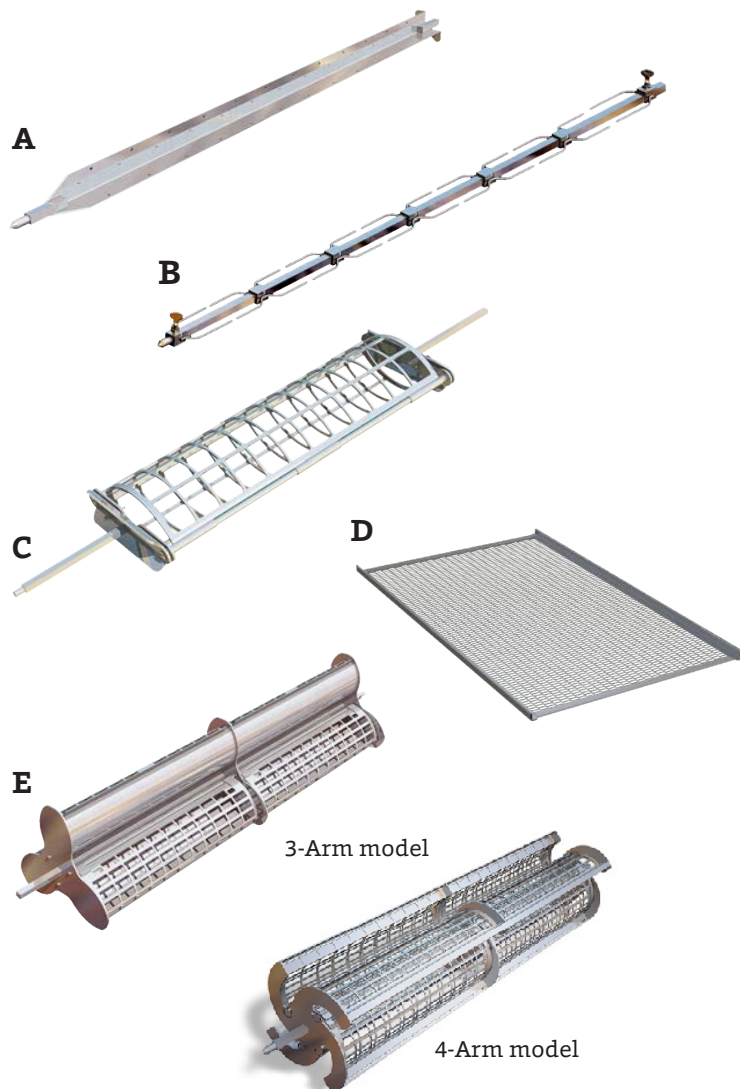



**G. PIG SPIT ASSEMBLY 000-319-PIG**

The Pig Spit Assembly features a spit made from half-inch square stainless steel stock, stainless steel end forks and an aluminum back brace. The assembly is suitable for roasting a 30–40 lb suckling pig or lamb.

**H. MULTI-SKEWER DRUM ASSEMBLY**

000-304-4-(34, 45 or 57)

The Multi-Skewer Drum Assembly is for use with the Okanogan Single-Spit Rotisserie. Available in 34", 45" and 57" widths. The assembly increases the capacity of 45" and 57" rotisseries from 3–4 chickens to 12–16 chickens at a time, turning the single-spit rotisserie into a powerful production unit. Increased capacity of the 34" model is from 2 chickens to 6–8 chickens.

**I. SPIT CART 000-CAS-CART**

This compact Spit Cart features a sturdy stainless steel body specifically designed to hold rotisserie spits upright, facilitating loading and storage. The cart measures 18 x 26.75", with a 40.25" overall height.

**J. GFR SMOKER BOX 000-322**

The Smoker Box is a perforated stainless steel box for use with the GFR gas-fired rotisserie to help influence flavor. It accommodates approximately 3.5 lbs of well soaked wood pieces and partially-ignited charcoal to create smoke. Wood and charcoal can be replenished during the cook cycle to maintain smoke.

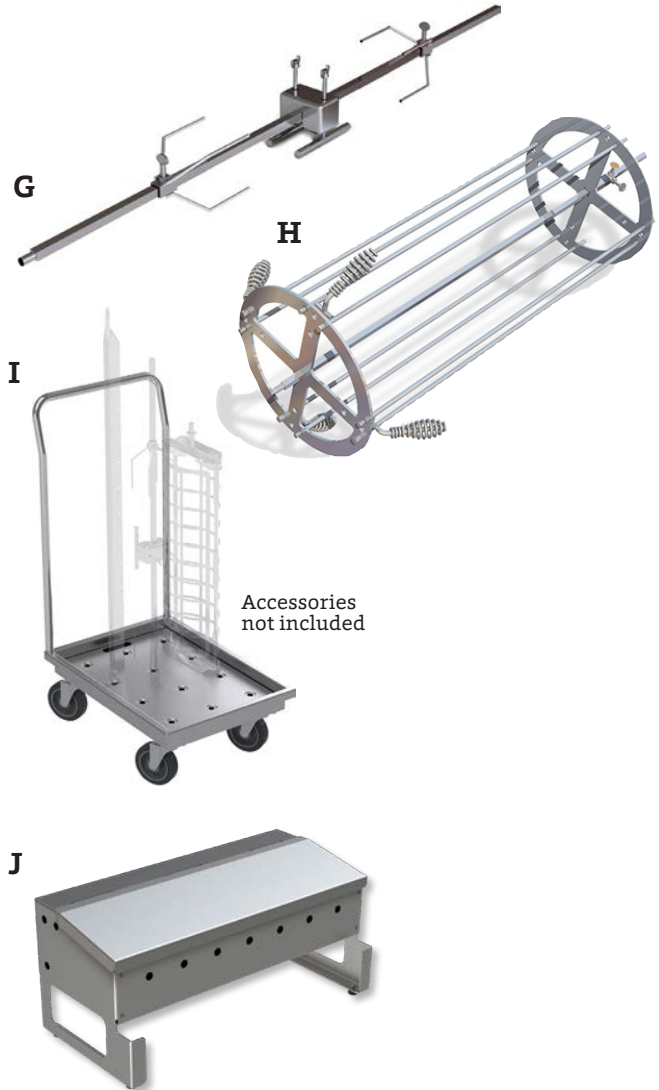



### **K. SPIT FORKS SINGLE** 000-301-S

A stainless steel, single direction two-prong Spit Fork, used for holding smaller product, such as chicken, in place on a Square Spit. For use with SFR, GFR and SSR rotisseries.

### **L. SPIT FORKS DOUBLE** 000-301-D

A stainless steel, double direction four-prong Spit Fork, used for holding smaller product, such as chicken, in place on a Square Spit. For use with SFR, GFR and SSR rotisseries.

### **M LARGE FORKS SINGLE** 000-319-LG-S

A stainless steel, single direction four-prong Spit Fork, used for holding larger product, such as turkey, in place on a Square Spit. For use with SFR, GFR and SSR rotisseries.

### **N. LARGE FORKS DOUBLE** 000-319-LG-D

A stainless steel, double direction eight-prong Spit Fork, used for holding larger product, such as turkey, in place on a Square Spit. For use with SFR, GFR and SSR rotisseries.

### **O. CHAIN ASSEMBLY FOR CLAMSHELL BASKET** 000-302

Replacement locking mechanism for the Clamshell Basket.

### **P. PUSH RELEASE BASKET PIN** 50RO-0001

Replacement locking pin on the Chain Assembly For Clamshell Basket.

### **Q. STANDARD BROILER GRATE** 50RO-0017

Replacement 6 x 24" Standard Broiler Grate for all Mt. Olympus Rotisseries with Optional Charbroiler. See table below for quantities.

Model	6 x 24" Grates
SFR-(6, 10)	7
SFR-(6, 10)-N	5

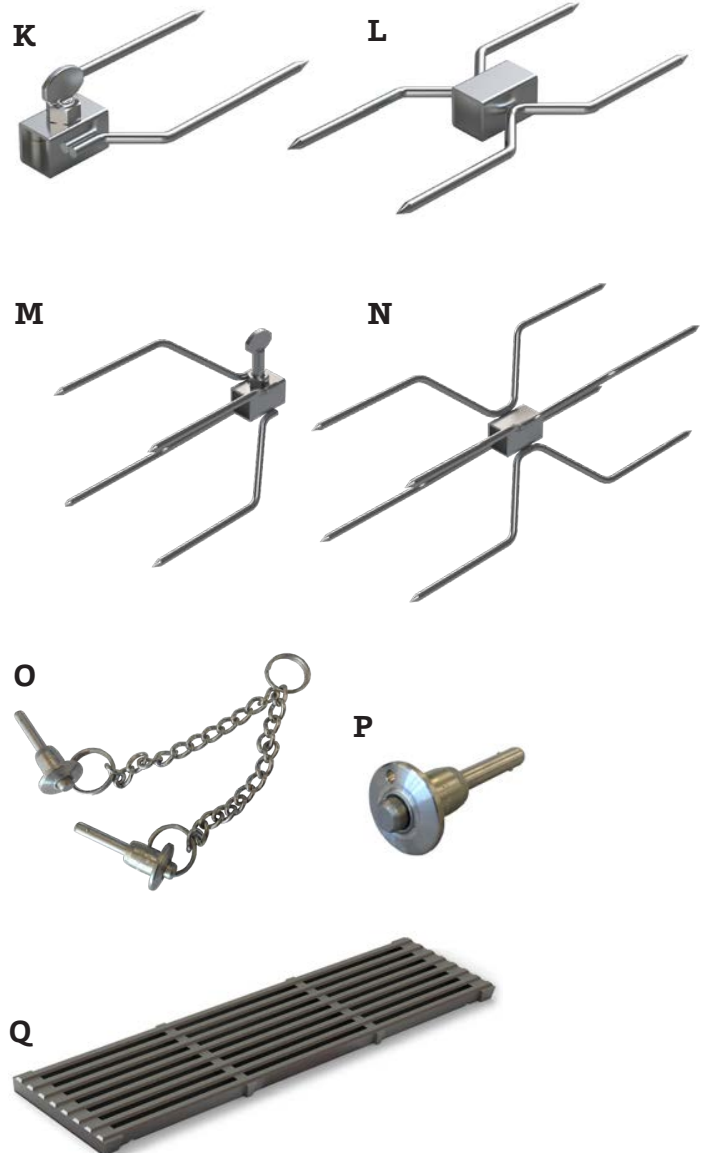



## CHICKEN ACCESSORIES

### A. CHICKEN BELL CHOIR 000-318-CBELL-CHOIR

A choir of 3 stainless steel "bells" for cooking 3 chickens on the Whatcom Gas Vertical Rotisserie (GVR). Includes one Chicken Top Bell and two standard Chicken Bells.

### B. CHICKEN BELL 000-318-BELL

Replacement standard Chicken Bell for cooking chickens on the Whatcom GVR. Must hang below a Top Bell.

### C. CHICKEN TOP BELL 000-318-TPBELL-C

Replacement Chicken Top Bell for cooking chickens on the Whatcom GVR. Includes "S" hook for attachment to the rotisserie and can be used to hang two more standard Chicken Bells to complete a "choir".

**Note:** Wood Stone recommends using chickens between 3 and 5 lbs. for optimum performance in this rotisserie.

A



B



C



## TURKEY ACCESSORIES

### D. TURKEY BELL CHOIR 000-318-TBELL-CHOIR

A choir of 2 stainless steel bells for cooking 2 turkeys on the Whatcom GVR. Includes one Top Turkey Bell and one standard Turkey Bell.

### E. TURKEY BELL 000-318-BELL-T

Replacement standard Turkey Bell for cooking turkeys on the Whatcom GVR. Must hang below a Turkey Top Bell.

### F. TURKEY TOP BELL 000-318-TPBELL-T

Replacement Turkey Top Bell for cooking turkeys on the Whatcom GVR. Includes "S" Hook for attachment to the rotisserie and can be used to hang one more standard Turkey Bell to complete a "choir".

**Note:** Wood Stone recommends using 10 lb. turkeys for optimum performance in this rotisserie.

D



E



F



### G. REPLACEMENT HOOK 000-318-HOOK

Stainless steel "S" Replacement Hook for hanging accessories.

### H. KEEPER CLIP 000-318-CLIP

Replacement clip for Whatcom GVR and Tandoor skewers, keeping product from falling off the end of a skewer.

G



H





### **I. DUCK HOOK** 000-318-DUCK-HOOK

A two-prong, 9" Duck Hook, for use with the Duck Oven or Whatcom GVR, this hook system allows for the easy hanging of Peking duck, other fowl, or roasts needing more than one attachment point for balance.

### **J. THREE-PRONGED RIB HOOK** 000-318-PRONG

Three-Pronged Rib Hook with the following capacities:  
Baby Back Ribs: Avg. weight 1.5 lbs., St. Louis Ribs: 2 lbs.

### **K. SKEWER** 000-318-SKEWER

The Skewer rod is 23" long, and can hold product of 2.25" maximum radius (center to outside measurement) to utilize all hooks on the GVR (GVR-6 and GVR-10 models); 4.5" maximum radius to utilize 5 hooks. Includes "S" Hook, Keeper Clip and Skewer rod.

### **L. CHURRASCO SKEWER** 000-318-CHURRASCO-2

The thicker stainless steel Churrasco Skewer for larger proteins and vegetables up to 19.5" in length, including whole fish up to 8 lbs. Will hold 2 roasts up to 12 lbs. each. Prongs are 2". Excellent for tableside presentation.

### **M. LARGE ADJUSTABLE BASKET**

000-318-BASKET-LG

The Large Adjustable Basket is great for prime rib, pork loin, rack of pork, or any roast larger than 3" but less than 6.5" in diameter and up to 20 inches long.

### **N. SMALL ADJUSTABLE BASKET**

000-318-BASKET-SM

The Small Adjustable Basket is great for those who do not wish to skewer their food. Perfect for rack of lamb, tenderloins, small roasts and quail. The basket holds multiple products 3" in diameter and up to 20" long.

### **O. ADJUSTABLE BASKET RETENTION ROD**

000-318-BSKT-ROD

Replacement rod for Large and Small Adjustable Baskets.

### **P. UTILITY BASKET**

000-318-UBASKET

Cook brats/sausages, vegetables, fish, chicken wings and so much more! This accessory measures 24-7/8" x 7" x 2-1/2" and provides 400 square inches of cooking volume.

**I**



**J**



**K**



**L**



**M**

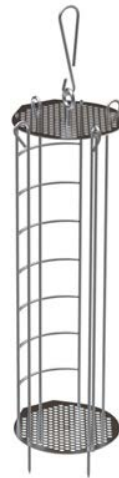

**N**



**O**



**P**

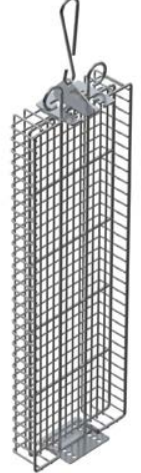



**Q. GVR - DELUXE ACCESSORY PACKAGE**

For the ultimate in flexibility and versatility, we've created the Whatcom GVR Deluxe Accessory Package. This set includes everything you need to cook anything you'd like - from ribs to chicken to veg to fish to skewers. If you want to push the limits of the versatility of our GVR, this package is for you.

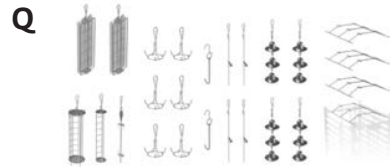

**R. GVR - DUCK ACCESSORY PACKAGE**

If you are looking to use our Whatcom Gas Vertical Rotisserie specifically for ducks, the Duck Accessory Package is for you.

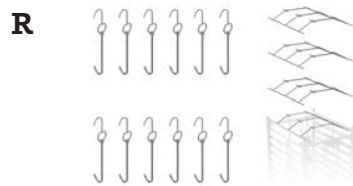

**S. GVR - RIB ACCESSORY PACKAGE**

If you are looking to use our Whatcom Gas Vertical Rotisserie specifically for ribs (up to 18 slabs an hour!), the Rib Accessory Package is for you.

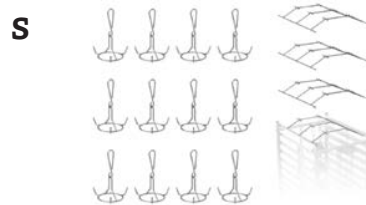

**T. GVR - CHICKEN ACCESSORY PACKAGE**

If you are looking to use our Whatcom Gas Vertical Rotisserie specifically for rotisserie chicken (up to 18 birds an hour!), this Chicken Accessory Package is for you.



**U. GVR - FULL ACCESSORY PACKAGE**

If you'd like the flexibility to cook proteins, veg (and everything in between) on our Whatcom Gas Vertical Rotisserie, then the Full Accessory Package is for you. Expand your menu and embrace the versatility these accessories have to offer!

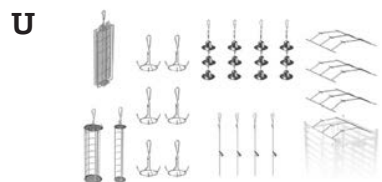

**V. GVR - CHICKEN & RIB ACCESSORY PACKAGE**

Looking to specifically roast just chicken and ribs in your Whatcom Gas Vertical Rotisserie? Then Chicken & Rib Accessory Package is for you!

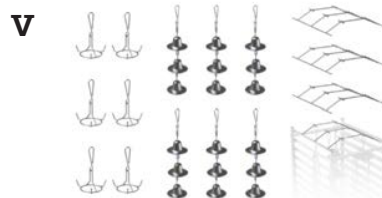



### **W. UTENSIL RACK 000-318-UTRACK**

The Whatcom GVR Utensil Rack slides onto any sheet pan cart shelf (not included). The rack features hooks on which to hang raw or cooked product using any of the accessories shown. Two Utensil Racks will fit on a standard speed cart.

### **X. GVR SMOKER TRAY 000-318-SMOKETRAY**

Stainless steel, two compartment GVR Smoker Tray for the Whatcom GVR. As it sits on the floor of the gas-fired rotisserie, the smoker tray acts as a flavor enhancer as well as imparting the distinctive aroma of a wood-fire.

**W**

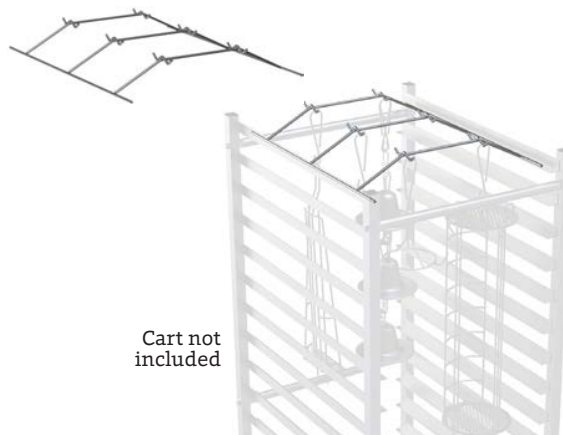

**X**



### **GAS-PLANCHA**

#### **A. PAN RAILS**

High quality, stainless steel pan rails with space for multiple 1/9th pans. Rests on top. Designed to be removed for easy cleaning. Pans sold separately.

PAN RAIL GPL 2436 50PL-1704 (Holds three pans.)

PAN RAIL GPL 3636 50PL-1005 (Holds five pans.)

PAN RAIL GPL 4836 50PL-1111 (Holds six pans.)

PAN RAIL GPL 6036 50PL-1904 (Holds six pans.)

**A**

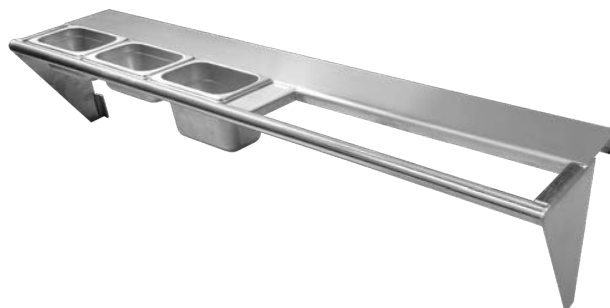



## WOOD-FIRED

### A. MINI-LIGNO E WOOD MOISTURE METER WS-TL-MM

Wood Stone's Mini-Ligno E Wood Moisture Meter instantly measures the moisture content of any type of wood, ensuring proper moisture content. Press the probes into the wood surface and the meter quickly displays the moisture percentage on the easy-to-read scale, ranging from 6–36%. An extra (longer) set of probes is included. The meter uses one 9V battery, good for 5,000 readings. The meter and the cap are built of high-impact plastic for years of use. The pocket-sized meter measures only 6 x 3 x 1" and weighs 6 ounces.

### B. FIRE HORSE 000-FIREHORSE

The Wood Stone stainless steel Fire Horse can help make your wood fire more efficient. The Fire Horse props up the logs, elevating them off the floor to allow more air to feed the fire.

## WOOD- OR COAL-FIRED

### C. PARTICLE SHOVEL WS-TL-PS-(S, M, L or XL)

Our heavy gauge stainless steel Particle Shovel is designed to safely remove ash and coals from wood-fired ovens and charbroilers. Its front is beveled to remove ash from even hard-to-reach corners. See page 5 for lengths.

## COAL-FIRED

### D. COAL OVEN RAKE

The triangular hoe-style Coal Oven Rake is useful in coal-fired ovens for manipulating coal inside the oven chamber, as well as scraping debris and fly ash through the coal grates and into the ash chute. Available in two lengths:

WS-TL-CR-M Medium Handle, 63"

WS-TL-CR-XL Extra Long Handle, 84"

### E. ASH CHUTE TOOL WS-TL-ACT-M

The 63" stainless steel Ash Chute Tool is useful for removing ash and small coal fragments from the ash chute on coal-fired ovens.

A



B



C



D



E





### F. COAL GRATES RP-GRATE-CL-SET

Two replacement Coal Grates, sold as a set, for Fire Deck Series coal ovens. Both 15.75" x 7.75" grates must be replaced at the same time.



### G. DOUBLE COMPARTMENT ASH DOLLY WS-TL-AD

The Wood Stone Double Compartment Ash Dolly is an efficient and safe means to store and transport the ash that needs to be removed from the oven each morning. It has two compartment sleeves for ash storage. After the first sleeve has been filled, the second sleeve should be filled. By the time the second sleeve has been filled, the first will have had time to cool and should be safe to dump. By separating the ash into two compartments, it is easier to control the disposal of leftover ash in a safe manner.

Caution is necessary to prevent any live coals mixed in with the ash from being dumped into an area or container with combustibles. Retain ashes in the closed container until all the cinders have thoroughly cooled. Ashes can then be disposed of safely.

The unit comes with a lock eye and a brass security lock with two keys. The unit is made of 16-gauge stainless steel with a non-marking perimeter bumper edge. It has four non-marking, fully revolving low profile casters.

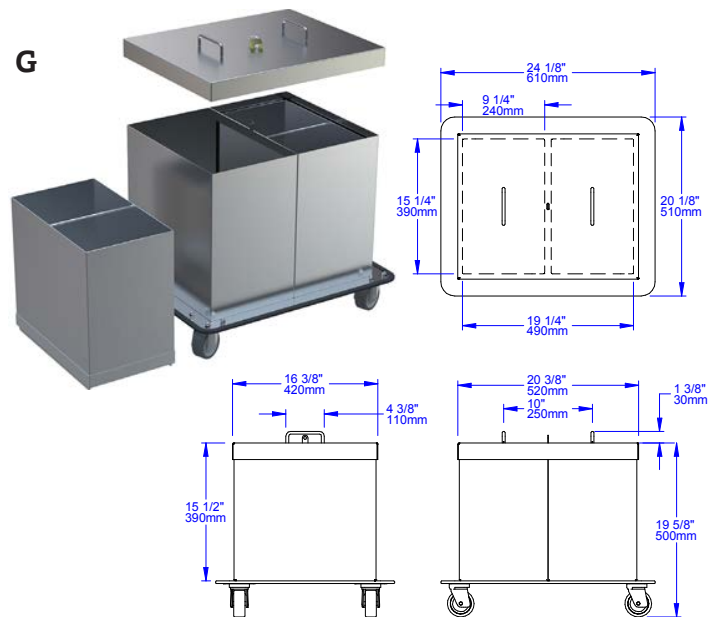

### H. WOOD HANDLING CART WS-TL-WHC

Wood Stone's stainless steel Wood Handling Cart is designed to address the day-to-day issue of transporting fuel from the main wood storage area to the solid fuel appliance. The 6.5-cubic-foot capacity cart is constructed from 14-gauge stainless steel. The cart is designed to hold 18-inch logs and to contain the accompanying bark chips and sawdust. It rolls easily over thresholds and carpeting on durable, 3 x 7/8", fully revolving, non-marking casters. This piece is built for a lifetime of reliable use.

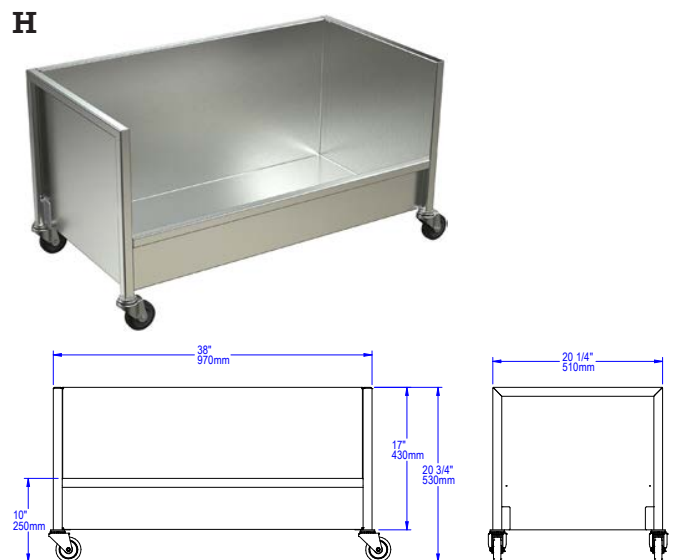

## Wood-Fired Tool Set



Note: various tool lengths are available. **PLEASE USE THE CHART BELOW TO MATCH YOUR OVEN TO THE RECOMMENDED TOOL LENGTH.**

### Long Wood Oven Tool Set (Pictured)

(1) loading peel (LP-12"),(1) utility peel, (1) brush set, (1) bubble hook and (1) particle shovel

### Wood Stone Tool Lengths

Tool	Short	Medium	Long	XLong
Loading Peel (LP-12")	32"	50"	60"	87"
Loading Peel (LP-16")	N/A	50"	60"	87"
Utility Peel (UP)	40"	60"	70"	87"
In-Line Floor Brush (IFB)	40"	60"	70"	87"
Natural Floor Brush (NFB)	36"	51"	70"	87"
Bubble Hook (BH)	40"	60"	70"	87"
Particle Shovel (PS)	40"	60"	70"	87"

What tool lengths does Wood Stone recommend for your oven?

Short	Medium	Long	XLong
Bistro Line 3030	Bistro Line 4355	Mt. Baker 6'	Fire Deck 9690
Bistro Line 4343	Mt. Adams 5'	Fire Deck 11275	Fire Deck 11290
Bistro Line 4836	Fire Deck 6045		Mt. Rainier 7'
Mt. Chuckanut 4'	Fire Deck 8645		
	Fire Deck 9660		
	Fire Deck 11260		

## Utility Peel

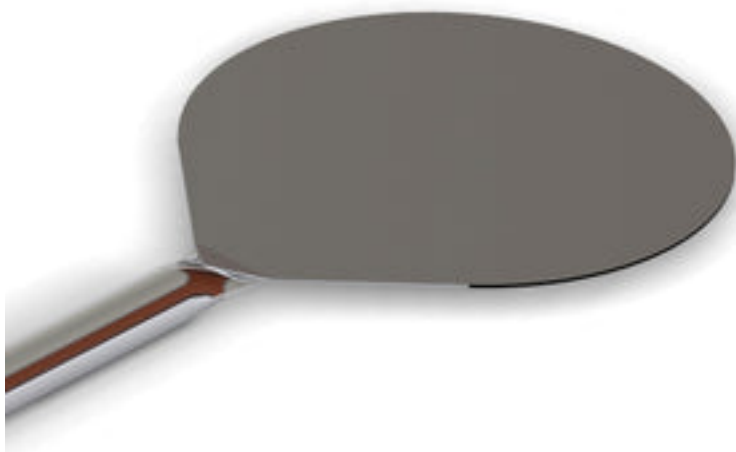

Note: various tool lengths are available. **PLEASE USE THE CHART BELOW TO MATCH YOUR OVEN TO THE RECOMMENDED TOOL LENGTH.**

### Utility Peel

Move or rotate any size pizza with nearly surgical precision with Wood Stone's Utility Peel. The 8-inch diameter utility peel is also very useful for moving pans, placing wood on the fire and removing ash. This is such a useful tool that most people order two. Select lengths available in either stainless steel or titanium versions.

Tool lengths are measured from end to end.

Tool	Part Number	S = Short	M = Medium	L = Long	XL = XLong
Utility Peel	WS-TL-UP-(S, M, L, XL)	40"	60"	70"	87"
Utility Peel — TITANIUM	WS-TL-UP-T-(S, M, L, XL)	40"	60"	70"	N/A"

What tool lengths does Wood Stone recommend for your oven?

Short	Medium	Long	XLong
Bistro Line 3030	Bistro Line 4355	Mt. Baker 6'	Fire Deck 9690
Bistro Line 4343	Mt. Adams 5'	Fire Deck 11275	Fire Deck 11290
Bistro Line 4836	Fire Deck 6045		Mt. Rainier 7'
Mt. Chuckanut 4'	Fire Deck 8645		
	Fire Deck 9660		
	Fire Deck 11260		

## Utility Basket

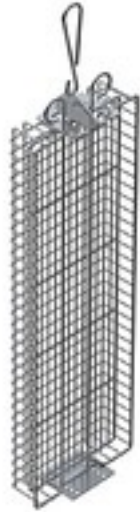

### Utility Basket

000-318-UBASKET

Extend the versatility of your 6 or 10 spit Whatcom Gas Vertical Rotisserie with our Utility Basket. Cook brats/sausages, vegetables, fish, chicken wings and so much more! This accessory measures 24 7/8" x 7" x 2 1/2" and provides 400 square inches of cooking volume.

*Compatible with both GVR-10 and GVR-6.*

## Utensil Rack



### Utensil Rack

000-318-URACK

The Whatcom Gas Vertical Rotisserie Utensil Rack slides onto any sheet pan cart shelf (not included). The rack features hooks on which to hang raw or cooked product using any of the accessories shown for the WS-GVR.

## Turkey TOP Bell Assembly



### **Turkey TOP Bell Assembly**

000-318-TPBELL-T

Replacement Turkey Top Bell for cooking turkeys on the Whatcom GVR. Includes «S» Hook for attachment to the rotisserie and can be used to hang one more standard Turkey Bell to complete a «choir».

## Turkey Bell Choir



### **Turkey Bell Choir**

000-318-TBELL-CHOIR

A choir of 2 stainless steel bells for cooking 2 turkeys on the Whatcom Gas Vertical Rotisserie. Includes one Top Turkey Bell and one standard Turkey Bell.

## Turkey Bell



### **Turkey Bell**

000-318-BELL-T

Turkey Top Bell for cooking turkeys on the Whatcom GVR. Must hang below a Turkey Top Bell. For use with Wood Stone Whatcom Gas Vertical Rotisserie (WS-GVR).

## Traditional Series Ovens

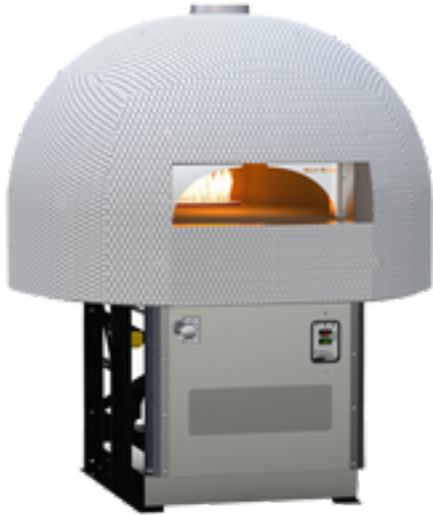

### Traditional Series Oven

**Available in multiple sizes, fuel configurations and ready to accept your tile or stucco finish:**

Traditional Series ovens are available in the following sizes:

- TS 5
- TS-6

Traditional Series ovens are available in the following fuel configurations:

- Radiant Flame Gas (-RFG)
- Radiant Flame Gas + Infrared Burner (-RFG-IR)
- Radiant Flame Gas + Infrared Burner + Wood (-RFG-IR-W)
- Radiant Flame Gas + Wood (-RFG-W)
- Wood + Infrared Burner (-W-IR)
- Wood only (-W)

## Tool Set For Tandoor



### Tool Set For Tandoor

WS-TL-SET-TANDOOR

The Tool Set For Tandoor includes one Tandoor Naan Hook (WS-TL-SK-HOOK), one Tandoor Naan Scraper (WS-TL-SK-SCRAPER) and 10 Tandoor Skewers (WS-TL-SK).

## Tool Grip



### Tool Grip

Replacement grease-resistant Tool Grip for any stainless steel handled Wood Stone oven tool.

## Titanium Utility Peel - 8"

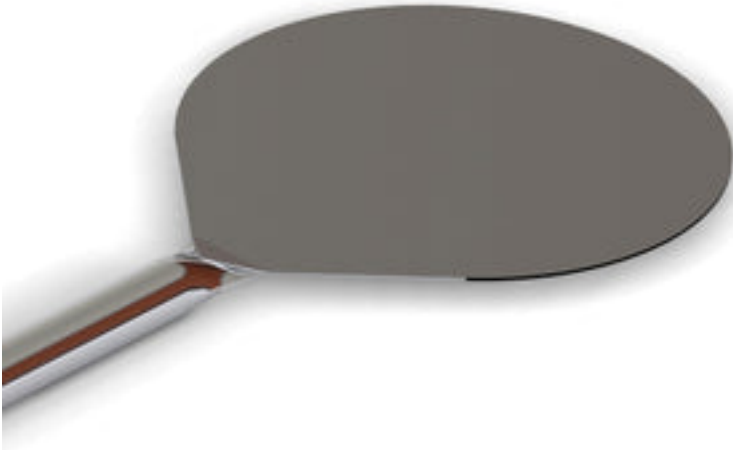

Note: various tool lengths are available. **PLEASE USE THE CHART BELOW TO MATCH YOUR OVEN TO THE RECOMMENDED TOOL LENGTH.**

### Titanium Utility Peel

Move or rotate any size pizza with nearly surgical precision with Wood Stone's Utility Peel. The 8-inch diameter utility peel is also very useful for moving pans, placing wood on the fire and removing ash. This is such a useful tool that most people order two. Select lengths available in either stainless steel or titanium versions..

Tool lengths are measured from end to end.

Tool	Part Number	S = Short	M = Medium	L = Long	XL = XLong
Utility Peel	WS-TL-UP-(S, M, L, XL)	40"	60"	70"	87"
Utility Peel — TITANIUM	WS-TL-UP-T-(S, M, L, XL)	40"	60"	70"	N/A"

What tool lengths does Wood Stone recommend for your oven?

Short	Medium	Long	XLong
Bistro Line 3030	Bistro Line 4355	Mt. Baker 6'	Fire Deck 9690
Bistro Line 4343	Mt. Adams 5'	Fire Deck 11275	Fire Deck 11290
Bistro Line 4836	Fire Deck 6045		Mt. Rainier 7'
Mt. Chuckanut 4'	Fire Deck 8645		
	Fire Deck 9660		
	Fire Deck 11260		

# Titanium Utility Peel - 10"

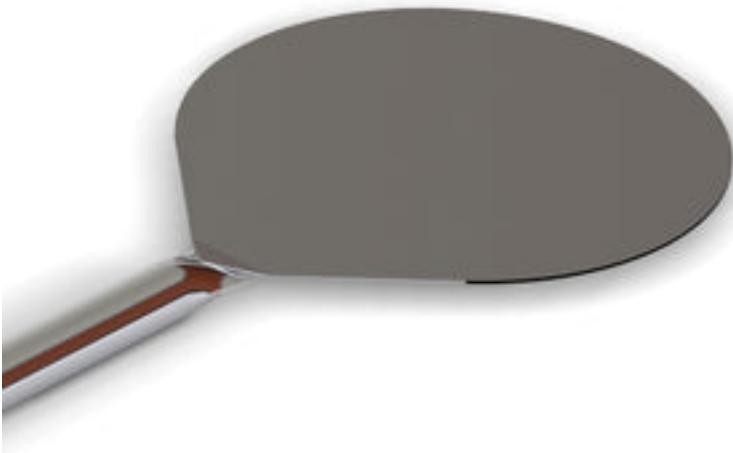

Note: various tool lengths are available. **PLEASE USE THE CHART BELOW TO MATCH YOUR OVEN TO THE RECOMMENDED TOOL LENGTH.**

## Titanium Utility Peel

Move or rotate any size pizza with nearly surgical precision with Wood Stone’s Utility Peel. The 8-inch diameter utility peel is also very useful for moving pans, placing wood on the fire and removing ash. This is such a useful tool that most people order two. Select lengths available in either stainless steel or titanium versions..

Tool lengths are measured from end to end.

Tool	Part Number	S = Short	M = Medium	L = Long	XL = XLong
Utility Peel	WS-TL-UP-(S, M, L, XL)	40"	60"	70"	87"
Utility Peel — TITANIUM	WS-TL-UP10-T-(S, M, L, XL)	40"	60"	70"	N/A"

What tool lengths does Wood Stone recommend for your oven?

Short	Medium	Long	XLong
Bistro Line 3030	Bistro Line 4355	Mt. Baker 6’	Fire Deck 9690
Bistro Line 4343	Mt. Adams 5’	Fire Deck 11275	Fire Deck 11290
Bistro Line 4836	Fire Deck 6045		Mt. Rainier 7’
Mt. Chuckanut 4’	Fire Deck 8645		
	Fire Deck 9660		
	Fire Deck 11260		

## Three-Pronged Rib Hook



### Three-Pronged Rib Hook

000-318-PRONG

Three-Pronged Rib Hook with the following capacities: Baby Back Ribs: Avg. weight 1.5 lbs., St. Louis Ribs: 2 lbs., Salmon Fillet: Up to 3 lbs. For use with Wood Stone Whatcom Gas Vertical Rotisserie (WS-GVR).

## Tandoor Skewer (SEEKH)



### Tandoor Skewer (SEEKH)

WS-TL-SK

The 37" Tandoor Skewer is designed for vegetables and proteins. The stainless steel skewer includes one Keeper Clip (000-318-CLIP).

## Tandoor Naandle



### Tandoor Naandle

WS-TL-NAANDLE

The Tandoor Naandle replicates a traditional Naan pillow. The pillow covers a spring-loaded aluminum plate with a stainless steel handle and grease-resistant grip to allow for easy application of the Naan bread to the interior walls of the Tandoor. *Please note: its overall length is 34".*

## Tandoor Naan Scraper



### **Tandoor Naan Scraper**

WS-TL-SK-SCRAPER

The 37" Tandoor Naan Scraper is used in conjunction with the Tandoor Naan Hook to remove Naan bread in the traditional method. Handcrafted by Wood Stone.

## Tandoor Naan Hook



### **Tandoor Naan Hook**

WS-TL-SK-HOOK

The 37" Tandoor Naan Hook is used in conjunction with the Tandoor Naan Scraper for the traditional preparation of Naan bread, allowing efficient removal of multiple loaves. This handcrafted stainless steel tool is built to last.

## **Tandoor 9" Naandle Canvas Cover**



### **Tandoor 9" Naandle Canvas Cover**

3000-0017

Replacement Canvas Cover for the Tandoor Naandle (WS-TL-NAANDLE).

## T-Style Natural Fiber Floor Brush



Note: various tool lengths are available. **PLEASE USE THE CHART BELOW TO MATCH YOUR OVEN TO THE RECOMMENDED TOOL LENGTH.**

### T-Style Floor Brush

The heavy-duty T-Style Natural Fiber Floor Brush features a 10" wood head, beveled to facilitate debris removal from all corners of the oven. The brush head is replaceable.

Need more than one style of brush? Check the Wood Stone Gas and Wood-Fired Floor Brush Sets.

Tool lengths are measured from end to end.

Tool	Part Number	S = Short	M = Medium	L = Long	XL = XLong
Natural Fiber Brush: T Style	WS-TL-TNFB-(S, M, L, XL)	40"	60"	70"	87"

### What tool lengths does Wood Stone recommend for your oven?

Short	Medium	Long	XLong
Bistro Line 3030	Bistro Line 4355	Mt. Baker 6'	Fire Deck 9690
Bistro Line 4343	Mt. Adams 5'	Fire Deck 11275	Fire Deck 11290
Bistro Line 4836	Fire Deck 6045		Mt. Rainier 7'
Mt. Chuckanut 4'	Fire Deck 8645		
	Fire Deck 9660		
	Fire Deck 11260		

## T-Style Natural Fiber Brush Replacement Heads (2 pk.)



### T-Style Natural Fiber Brush Replacement Heads (2 pk.)

Brush length 10"

Need replacement heads for your T-Style Natural Fiber Brush? We now sell our T-Style Natural Fiber Brush Replacement Heads in a convenient 2 pack.

Tool	Part Number
T Style Natural Fiber Brush Replacement Heads	RP-3000-0060

## T-Style Brass Bristled Floor Brush

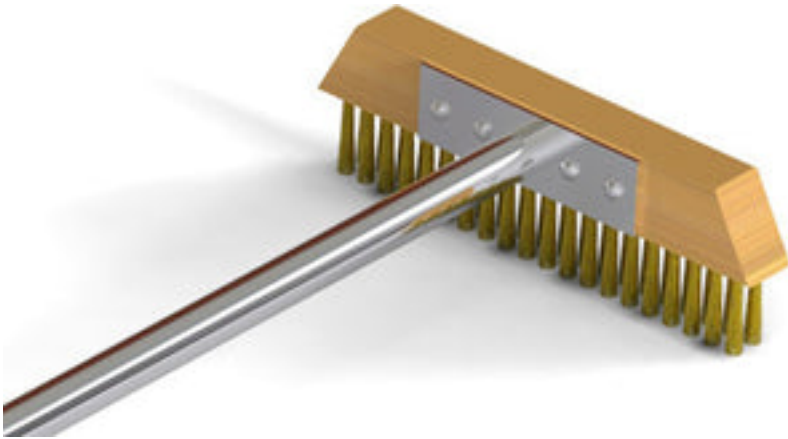

Note: various tool lengths are available. **PLEASE USE THE CHART BELOW TO MATCH YOUR OVEN TO THE RECOMMENDED TOOL LENGTH.** If you have questions about which oven model you have and which tool length you need, please contact us at 1.360.650.1111, M-F 8AM-5PM PST.

---

### T-Style Floor Brush

The heavy-duty T-Style Brass-Bristled Floor Brush features a 10" wood head, beveled to facilitate debris removal from all corners of the oven. The brush head is replaceable.

Need more than one style of brush? Check the Wood Stone Gas and Wood-Fired Floor Brush Sets.

Tool lengths are measured from end to end.

Tool	Part Number	S = Short	M = Medium	L = Long	XL = XLong
Brass Bristle Brush: T Style	WS-TL-TFB-(S, M, L, XL)	40"	60"	70"	87"

What tool lengths does Wood Stone recommend for your oven?

Short	Medium	Long	XLong
Bistro Line 3030	Bistro Line 4355	Mt. Baker 6'	Fire Deck 9690
Bistro Line 4343	Mt. Adams 5'	Fire Deck 11275	Fire Deck 11290
Bistro Line 4836	Fire Deck 6045		Mt. Rainier 7'
Mt. Chuckanut 4'	Fire Deck 8645		
	Fire Deck 9660		
	Fire Deck 11260		

## Standard Angle Spit



### Standard Angle Spit

000-307

**PLEASE NOTE: Due to the variations in spit lengths, each is Standard Angle Spit is custom cut to order.** The Standard Angle Spit is included with all Wood Stone rotisseries. Six to seven average-sized birds can be quickly loaded. For Wood Stone SFR and GFR rotisseries.

## Stainless Steel Shelf



### Stainless Steel Shelf

A high quality, stainless steel work shelf with an under-slung utensil rail for hanging tongs or other grill tools. **Note:** One (-45) Stainless Steel Shelf can be mounted on either side, and two shelves will fit on the front of all charbroiler models, except the SFB-5426. Two (-29) shelves can fit on the front of the SFB-5426. Three (-45) shelves can fit on the SFB-72.  
(000-401-29 image shown)

## Square Spits with Adjustable Forks



### Square Spits with Adjustable Forks

000-306

**PLEASE NOTE: Due to the variations in spit lengths, each is Square Spit is custom cut to order.**

The Square Spit With Adjustable Forks is made of half-inch square stock stainless steel and comes with 5 double forks and two single forks. The spit holds from 1 to 6 birds of various size. For Wood Stone SFR and GFR rotisseries only.

## Spit Forks Single



### Spit Forks Single

000-301-S

A stainless steel, single direction two-prong Spit Fork, used for holding smaller product, such as chicken, in place on a Square Spit. (For use with Wood Stone SFR, GFR and SSR rotisseries).

## Spit Forks Double

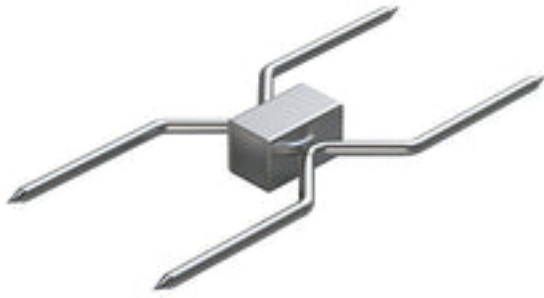

### Spit Forks Double

000-301-D

A stainless steel, double direction four-prong Spit Fork, used for holding smaller product, such as chicken, in place on a Square Spit. (For use with Wood Stone SFR, GFR and SSR rotisseries).

## Smoker Box



Wood Stone's Smoker Box uses wood chips to give the aroma of a wood-fired oven in a gas-fired oven. Constructed of heavy-duty stainless steel for years of service. The box is 9-1/2" long x 4-1/4" wide x 2" deep.

## Small Adjustable Basket



### Small Adjustable Basket

000-318-BASKET-SM

The Small Adjustable Basket is great for those who do not wish to skewer their food. Perfect for rack of lamb, tenderloins, small roasts and quail. The basket holds multiple products 3" in diameter and up to 20" long. For use with Wood Stone Whatcom Gas Vertical Rotisserie (WS-GVR).

## Skewer (WS-GVR)



### **Skewer (WS-GVR)**

000-318-SKEWER

The Skewer rod is 23" long, and can hold product of 2.25" maximum radius (center to outside measurement) to utilize all ten hooks; 4.5" maximum radius to utilize 5 hooks. Includes «S» Hook, Keeper Clip and Skewer rod.

## Skewer (Satay) Rack



### **Skewer (Satay) Rack**

Stainless steel Skewer (Satay) Rack perfect for satay, kabobs or skewers. For SFB-34", 45", 54", 57", or 72" widths.

## Short Loading Peel



Note: various tool lengths are available. **PLEASE USE THE CHART BELOW TO MATCH YOUR OVEN TO THE RECOMMENDED TOOL LENGTH.**

### Short Loading Peel

Introducing Wood Stone Loading Peels from Zio Pepe.

These durable, yet lightweight aluminum alloy loading peels come in five sizes that are perfect for up to 12", 14", 16" and 18" pizzas. A 13" loading peel is available in stainless steel. The short tool set includes only the 12" Loading Peel. The medium, long, and extra long tool sets include both the 12" and the 16" Loading Peels.

Tool lengths are measured from end to end.

Tool	Part Number	S = Short	M = Medium	L = Long	XL = XLong
Loading Peel 12"	WS-TL-LP-12-(S, M, L, XL)	32"	50"	60"	87"
Loading Peel 14"	WS-TL-LP-14-(S, M, L, XL)	32"	50"	60"	87"
Loading Peel 16"	WS-TL-LP-16-(M, L, XL)	N/A	50"	60"	87"
Loading Peel 18"	WS-TL-LP-18-(M, L, XL)	N/A	50"	60"	87"

What tool lengths does Wood Stone recommend for your oven?

Short	Medium	Long	XLong
Bistro Line 3030	Bistro Line 4355	Mt. Baker 6'	Fire Deck 9690
Bistro Line 4343	Mt. Adams 5'	Fire Deck 11275	Fire Deck 11290
Bistro Line 4836	Fire Deck 6045		Mt. Rainier 7'
Mt. Chuckanut 4'	Fire Deck 8645		
	Fire Deck 9660		
	Fire Deck 11260		

# Scraper Tool



Note: various tool lengths are available. **PLEASE USE THE CHART BELOW TO MATCH YOUR OVEN TO THE RECOMMENDED TOOL LENGTH.**

---

## Scraper Tool

The Scraper Tool is useful for scraping the deck floor and removing heavy, baked-on debris and buildup. A stainless steel handle, grease-resistant grip and angled head provide plenty of leverage, even in the rear of the oven.

Tool	Part Number	S/M = Small/Medium	L = Long	XL = XLong
Scraper Tool	WS-TL-S-(S, M, L, XL)	60"	70"	80"

What tool lengths does Wood Stone recommend for your oven?

Small	Medium	Long	XLong
Bistro Line 3030	Bistro Line 4355	Mt. Baker 6'	Fire Deck 9690
Bistro Line 4343	Mt. Adams 5'	Fire Deck 11275	Fire Deck 11290
Bistro Line 4836	Fire Deck 6045		Mt. Rainier 7'
Mt. Chuckanut 4'	Fire Deck 8645		
	Fire Deck 9660		
	Fire Deck 11260		

## S Hook Hanger



### S Hook Hanger

000-318-HOOK

Stainless steel «S» Replacement Hook for hanging accessories. For use with Wood Stone Whatcom Gas Vertical Rotisserie (WS-GVR).

## Rib / Fish Basket Spit



### Rib / Fish Basket Spit

000-311-(R, L) 3-arm, 6 compartment

000-303-(4R,4L) 4-arm, 8 compartment

**PLEASE NOTE: Due to the variations in spit lengths, each Rib/Fish Basket Spit is custom cut to order.**

The Rib/ Fish Basket Spit is available in a 3-arm, 6 compartment, or in a 4-arm, 8 compartment model. On the 4-arm spit, each compartment is suitable for a full rack of ribs, a sizeable salmon fillet or several smaller cuts of meat. On the 3-arm spit, the size of each compartment makes it ideal for larger items such as tri-tip roasts and pork loins. The laser-cut containment flap is spring-loaded for easy loading and unloading.

## Push Release Basket Pin



### **Push Release Basket Pin**

Replacement locking pin on the Chain Assembly for Clamshell Basket. For Wood Stone Clamshell Basket (000-300).

## Pita Peel



### **Pita Peel**

WS-TL-PP-63

The 63" basket-style Pita Peel is designed for scooping up multiple pitas and finishing them in the dome and removing them.

## Particle Shovel



Note: various tool lengths are available. **PLEASE USE THE CHART BELOW TO MATCH YOUR OVEN TO THE RECOMMENDED TOOL LENGTH.**

### Particle Shovel

Our heavy gauge stainless steel shovel is designed to safely remove ash and coals from wood-fired and coal-fired ovens. Its front is beveled to remove ash from even hard to reach parts of the oven. Available in multiple lengths.

Tool lengths are measured from end to end.

Tool	Part Number	S = Short	M = Medium	L = Long	XL = XLong
Particle/Ash Shovel	WS-TL-PS-(S, M, L, XL)	40"	60"	70"	87"

What tool lengths does Wood Stone recommend for your oven?

Short	Medium	Long	XLong
Bistro Line 3030	Bistro Line 4355	Mt. Baker 6'	Fire Deck 9690
Bistro Line 4343	Mt. Adams 5'	Fire Deck 11275	Fire Deck 11290
Bistro Line 4836	Fire Deck 6045		Mt. Rainier 7'
Mt. Chuckanut 4'	Fire Deck 8645		
	Fire Deck 9660		
	Fire Deck 11260		

## Oven Tool Hanger (Not Zio Pepe)



### Tool Hanger (Not Zio Pepe)

1650118

Wood Stone's Oven Tool Hanger offers a convenient way to have your tools easily accessible while cooking. The hanger is 2.5" wide x 3.5" deep x 2.075" high.

## Night Heat Retention Doors



VARIOUS SIZES AVAILABLE. PLEASE ENSURE YOU SELECT THE CORRECT SIZE FOR YOUR OVEN AS A 25% RESTOCKING FEE WILL BE CHARGED ON RETURNS.

---

### **Night Heat Retention Doors**

Conserve the heat of your oven overnight using Night Heat Retention Doors. They are constructed of stainless steel, with spring handles.

**Note: Night Doors must be removed prior to oven operation and should only be used when the oven is turned OFF for heat retention.**

\*Items consist of a two-door set

## Natural Fiber Brush Replacement Heads (2 pk.)



### Natural Fiber Brush Replacement Heads (2 pk.)

Brush length: 28-1/4"

If you have an ALL WOOD natural fiber brush, you must replace the entire Natural Fiber Brush with WS-TL-NFB-S (36") or WS-TL-NFB-M (51").

Need replacement heads for your natural fiber brush? We sell them in a convenient 2 pack which fit our Long and Extra long Natural Fiber Brush tool handles.

Please note, your **brush handle MUST BE stainless steel** in order for this replacement head to fit. Both our Long and Extra Long Natural Fiber brush handles are stainless steel.

Tool	Part Number
Natural Fiber Brush Replacement Heads	3000-0037

## Natural Fiber Brush

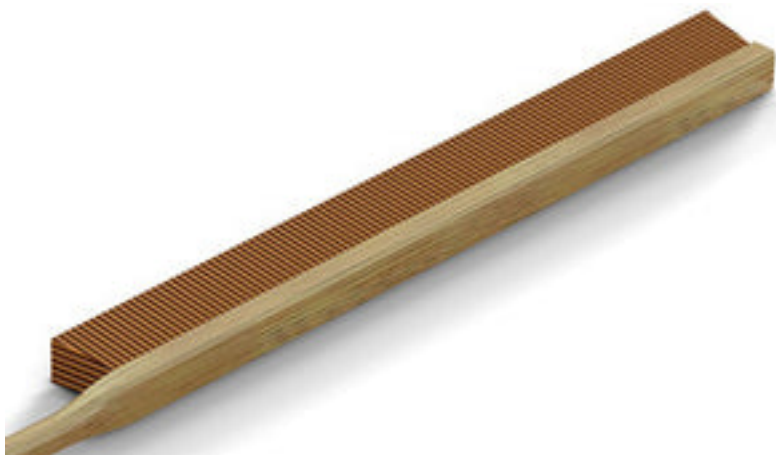

Note: various tool lengths are available. **PLEASE USE THE CHART BELOW TO MATCH YOUR OVEN TO THE RECOMMENDED TOOL LENGTH.**

### Natural Fiber Brush

For general sweeping, we offer a Natural Fiber Brush. The short and medium lengths have wood handles. The long and extra long lengths have stainless steel handles and replaceable heads.

Tool lengths are measured from end to end.

Tool	Part Number	S = Short	M = Medium	L = Long	XL = XLong
Natural Fiber Brush	WS-TL-NFB-(S, M, L, XL)	36"	51"	70"	87"

What tool lengths does Wood Stone recommend for your oven?

Short	Medium	Long	XLong
Bistro Line 3030	Bistro Line 4355	Mt. Baker 6'	Fire Deck 9690
Bistro Line 4343	Mt. Adams 5'	Fire Deck 11275	Fire Deck 11290
Bistro Line 4836	Fire Deck 6045		Mt. Rainier 7'
Mt. Chuckanut 4'	Fire Deck 8645		
	Fire Deck 9660		
	Fire Deck 11260		

## Mt. St. Helens Searing Plate



Replace a 6' x 24" Standard Broiler Grate with a Searing Plate to sear scallops, saute chopped veggies or even make pancakes! Made of polished mild steel.

NOTE: These searing plates are NOT compatible with our Jisper Charcoal Broiler Oven or Mt. St. Helens 5426.

**NO RETURNS ON SEARING PLATES.**

## Mt. St. Helens (5426) Broiler Grate



### Mt. St. Helens (5426) Broiler Grate

**50RO-0017-2**

Replacement 6" x 16" broiler grate for model SFB-5426 of the **Mt. St. Helens Charbroiler**. *Please note there are different grates for the 36" and 72" widths.*

#### **NO RETURNS ON GRILL GRATES.**

Please use the table below to select the correct replacement grates for your charbroiler. The number of grates shown represents the number of grates needed to cover the surface of your charbroiler. You may also contact customer service at 1.800.988.8103 for additional information.

**SHIPPING NOTE: Grates are very heavy. If ordering more than 4, they will ship 4 per box.**

**NOTE: These grates are NOT compatible with our Jospet Charcoal Broiler Oven.**

MODEL	CHARBROILER WIDTH	6" x 24" GRATES	6" x 16" GRATES	4" x 24" GRATES
SFB-34	34"	5		
SFB-45	45"	7		
SFB-57	57"	9		
SFB-72	72"	10 (+2 ea. 4" x 24")		2
<b>SFB-5426</b>	<b>54"</b>		<b>8</b>	

## Mountain Series Ovens



### Mountain Series Oven

THE FACADE-FRIENDLY CORNERSTONE.

**Available in multiple sizes, fuel configurations and custom finishes:**

Mountain Series ovens are available in the following sizes:

- Mt. Chuckanut 4'
- Mt. Adams 5'
- Mt. Baker 6'
- Mt. Rainier 7'

Mountain Series ovens are available in the following fuel configurations:

- Radiant Flame Gas (-RFG)
- Radiant Flame Gas + Infrared Burner (-RFG-IR)
- Radiant Flame Gas + Infrared Burner + Wood (-RFG-IR-W)
- Radiant Flame Gas + Wood (-RFG-W)
- Wood + Infrared Burner (-W-IR)
- Wood only (-W)

Our Mountain Series ovens are available in a number of custom finishes including custom color powder coat, stucco-ready and facade-ready.

## Moisture Meter



### Moisture Meter

Wood Stone's Mini-Lingo E Wood Moisture Meter instantly measures the moisture content of any type of wood, ensuring proper moisture content.

## Medium Loading Peel



Note: various tool lengths are available. **PLEASE USE THE CHART BELOW TO MATCH YOUR OVEN TO THE RECOMMENDED TOOL LENGTH.**

### Medium Loading Peel

Introducing Wood Stone Loading Peels from Zio Pepe.

These durable, yet lightweight aluminum alloy loading peels come in five sizes that are perfect for up to 12", 14", 16" and 18" pizzas. A 13" loading peel is available in stainless steel. The short tool set includes only the 12" Loading Peel. The medium, long, and extra long tool sets include both the 12" and the 16" Loading Peels.

Tool lengths are measured from end to end.

Tool	Part Number	S = Short	M = Medium	L = Long	XL = XLong
Loading Peel 12"	WS-TL-LP-12-(S, M, L, XL)	32"	50"	60"	87"
Loading Peel 14"	WS-TL-LP-14-(S, M, L, XL)	32"	50"	60"	87"
Loading Peel 16"	WS-TL-LP-16-(M, L, XL)	N/A	50"	60"	87"
Loading Peel 18"	WS-TL-LP-18-(M, L, XL)	N/A	50"	60"	87"

What tool lengths does Wood Stone recommend for your oven?

Short	Medium	Long	XLong
Bistro Line 3030	Bistro Line 4355	Mt. Baker 6'	Fire Deck 9690
Bistro Line 4343	Mt. Adams 5'	Fire Deck 11275	Fire Deck 11290
Bistro Line 4836	Fire Deck 6045		Mt. Rainier 7'
Mt. Chuckanut 4'	Fire Deck 8645		
	Fire Deck 9660		
	Fire Deck 11260		

## Long Loading Peel



Note: various tool lengths are available. **PLEASE USE THE CHART BELOW TO MATCH YOUR OVEN TO THE RECOMMENDED TOOL LENGTH.**

### Long Loading Peel

Introducing Wood Stone Loading Peels from Zio Pepe.

These durable, yet lightweight aluminum alloy Loading Peels come in four sizes that are perfect for up to 12", 14", 16" and 18" pizzas. The short tool set includes only the 12" Loading Peel. The medium, long, and extra long tool sets include both the 12" and the 16" Loading Peels.

Tool lengths are measured from end to end.

Tool	Part Number	S = Short	M = Medium	L = Long	XL = XLong
Loading Peel 12"	WS-TL-LP-12-(S, M, L, XL)	32"	50"	60"	87"
Loading Peel 14"	WS-TL-LP-14-(S, M, L, XL)	32"	50"	60"	87"
Loading Peel 16"	WS-TL-LP-16-(M, L, XL)	N/A	50"	60"	87"
Loading Peel 18"	WS-TL-LP-18-(M, L, XL)	N/A	50"	60"	87"

What tool lengths does Wood Stone recommend for your oven?

Short	Medium	Long	XLong
Bistro Line 3030	Bistro Line 4355	Mt. Baker 6'	Fire Deck 9690
Bistro Line 4343	Mt. Adams 5'		Fire Deck 11290
Mt. Chuckanut 4'	Fire Deck 6045		Mt. Rainier 7'
	Fire Deck 8645		
	Fire Deck 9660		
	Fire Deck 11260		

These durable, yet lightweight aluminum alloy loading peels come in five sizes that are perfect for up to 12", 14", 16" and 18" pizzas. A 13" loading peel is available in stainless steel

## Loading Peel Tool Hanger (2 pk.)



### Loading Peel Tool Hanger

RP-3000-0054

The Loading Peel Tool Hanger is specifically designed to accommodate all loading peels. The hanger is 4.5" wide x 1.625" deep.

## Large Adjustable Basket



### Large Adjustable Basket

000-318-BASKET-LG

The Large Adjustable Basket is great for prime rib, pork loin, rack of pork, or any roast larger than 3" but less than 6.5" in diameter and up to 20 inches long. For use with Wood Stone Whatcom Gas Vertical Rotisserie (WS-GVR).

## Keeper Clip



### Keeper Clip

000-318-CLIP

Replacement clip for Whatcom Gas Vertical Rotisserie (WS-GVR) and Tandoor skewers, keeping product from falling off the end of a skewer.

## In-Line Floor Brush for the Home

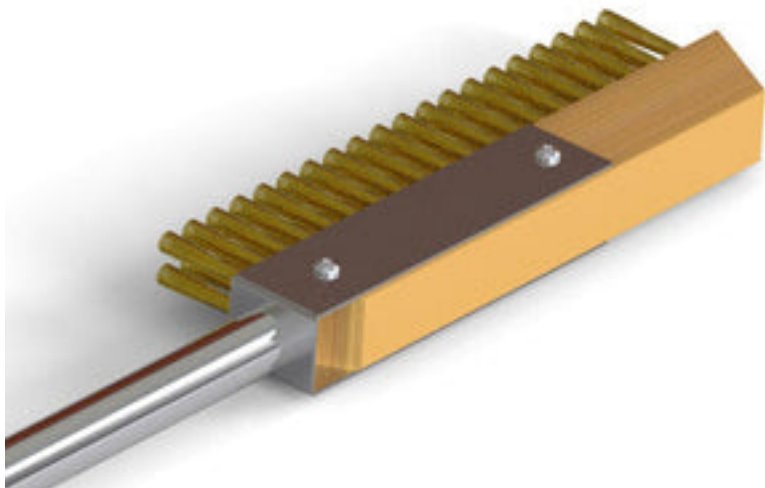

Note: various tool lengths are available. **PLEASE USE THE CHART BELOW TO MATCH YOUR OVEN TO THE RECOMMENDED TOOL LENGTH.**

### In-Line Floor Brush

The heavy-duty In-Line Brass-Bristled Brush features a 10" wood head, beveled to facilitate debris removal from all corners of the oven. The brush head is replaceable.

Need more than one style of brush? Make sure to check out our brush sets.

Available in multiple lengths.

Tool lengths are measured from end to end.

Tool	Part Number	S = Short	M = Medium
In-Line Floor Brush	WS-TL-IFB-(S, M, L, XL)	40"	60"

What tool lengths does Wood Stone recommend for your oven?

Short	Medium
Bistro Line 3030	Bistro Line 4355
Bistro Line 4343	Mt. Adams 5'
Bistro Line 4836	Fire Deck 6045
Mt. Chuckanut 4'	Fire Deck 8645
	Fire Deck 9660
	Fire Deck 11260

## In-Line Floor Brush

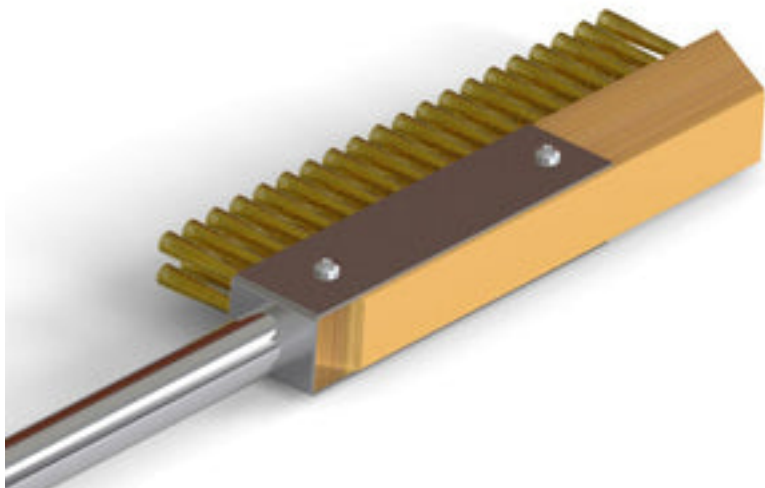

Note: various tool lengths are available. **PLEASE USE THE CHART BELOW TO MATCH YOUR OVEN TO THE RECOMMENDED TOOL LENGTH.** If you have questions about which oven model you have and which tool length you need, please contact us at 1.360.650.1111, M-F 8AM-5PM PST.

### In-Line Floor Brush

The heavy-duty In-Line Brass-Bristled Brush features a 10" wood head, beveled to facilitate debris removal from all corners of the oven. The brush head is replaceable.

Need more than one style of brush? Make sure to check out our brush sets.

Available in multiple lengths.

Tool lengths are measured from end to end.

Tool	Part Number	S = Short	M = Medium	L = Long	XL = XLong
In-Line Floor Brush	WS-TL-IFB-(S, M, L, XL)	40"	60"	70"	87"

What tool lengths does Wood Stone recommend for your oven?

Short	Medium	Long	XLong
Bistro Line 3030	Bistro Line 4355	Mt. Baker 6'	Fire Deck 9690
Bistro Line 4343	Mt. Adams 5'	Fire Deck 11275	Fire Deck 11290
Bistro Line 4836	Fire Deck 6045		Mt. Rainier 7'
Mt. Chuckanut 4'	Fire Deck 8645		
	Fire Deck 9660		
	Fire Deck 11260		

## Horseshoe Scraper Replacement Blade



Replacement blade for the Horseshoe Scraper

## Horseshoe Scraper



Removes charred food residue and grease from flat tops/griddles. Ergonomically designed construction for left or right-hand use. Constructed of heavy-duty cast aluminum and comes with a sharp stainless steel blade for long-lasting service. Features a long handle to keep operator's hands away from the hot surface. Easy blade replacement using hand screws 33" handle allows for added reach to make cleaning the entire flat top quick, easy and safe.

### DIRECTIONS FOR USE

1. Be sure not to scrape or chisel the flat top griddle when using the scraper. The scraper should be used in a shaving motion to remove excess residue from the griddle.
2. Do not lean or use excessive force when using the scraper. This could cause damage to the scraper, blade or griddle surface.
3. It is not necessary to remove all the residue from the griddle with the initial cleaning pass. Remove excess residue, then add water to flat top to create steam and shave the remaining residue into the grease trough.

## Hand Held IR Thermometer



### Hand Held IR Thermometer

This easy-to-use device allows instant surface temperature measurements anywhere in your Wood Stone oven.

## GVR - Rib Accessory Package

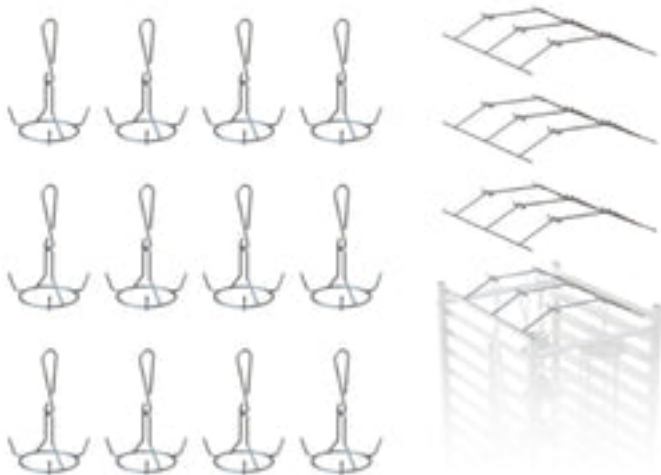

If you are looking to use our Whatcom Gas Vertical Rotisserie specifically for ribs (up to 18 slabs an hour!), the **Rib Accessory Package** is for you. It includes:

- Rib Hooks (000-318-PRONG), 12
- Utensil Rack (000-318-UTRACK), 4

## GVR - Full Accessory Package

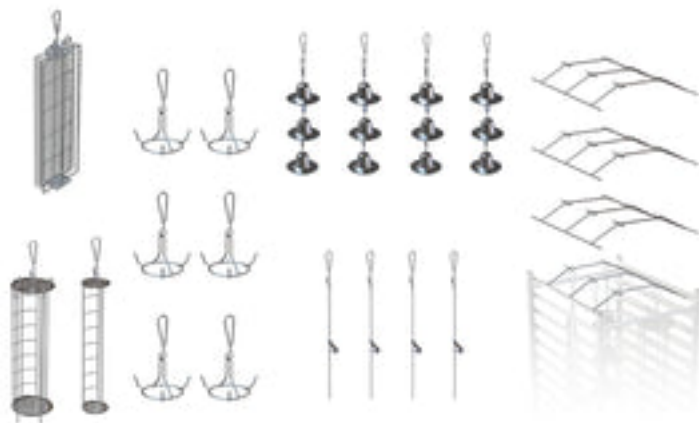

If you'd like the flexibility to cook proteins, veg (and everything in between) on our Whatcom Gas Vertical Rotisserie, then the **Full Accessory Package** is for you. Expand your menu and embrace the versatility these accessories have to offer! This set includes:

- Utility Basket (000-318-UBASKET), 1
- Chicken Bell Choir (000-318-CBELL-CHOIR), 4
- Large Protein Basket (000-318-BASKET-LG), 1
- Small Protein Basket (000-318-BASKET-SM), 1
- Rib Hooks (000-318-PRONG), 6
- Skewers (000-318-SKEWER), 4
- Utensil Rack (000-318-URACK), 4

## GVR - Duck Accessory Package

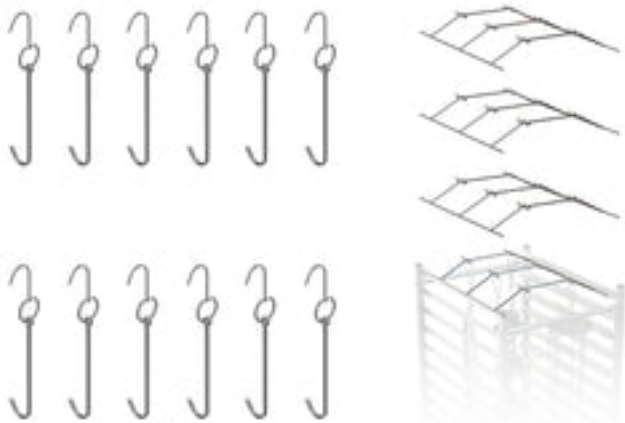

If you are looking to use our Whatcom Gas Vertical Rotisserie specifically for ducks, the **Duck Accessory Package** is for you. It includes:

- Duck Hooks (WS-TL-DO-DH), 12
- Utensil Rack (000-318-UTRACK), 4

## GVR - Chicken Accessory Package



If you are looking to use our Whatcom Gas Vertical Rotisserie specifically for rotisserie chicken (up to 18 birds an hour!), this **Chicken Accessory Package** is for you. It includes:

- Chicken Bell Choir (000-318-CBELL-Choir), 12
- Utensil Rack (000-318-UTRACK), 4

## GVR - Chicken & Rib Accessory Package



Looking to specifically roast just chicken and ribs in your Whatcom Gas Vertical Rotisserie? Then **Chicken & Rib Accessory Package** is for you! It includes:

- Chicken Bell Choir (000-318-CBELL-CHOIR), 6
- Rib Hooks (000-318-PRONG), 6
- Utensil Rack (000-318-UTRACK), 4

## GVR - Deluxe Accessory Package



For the ultimate in flexibility and versatility, we've created the Whatcom GVR **Deluxe Accessory Package**. This set includes everything you need to cook anything you'd like — from ribs to chicken to veg to fish to skewers. If you want to push the limits of the versatility of our GVR, this package is for you. It includes:

- Utility Basket (000-318-UBASKET), 2
- Large Protein Basket (000-318-BASKET-LG), 1
- Small Protein Basket (000-318-BASKET-SM), 1
- Churrasco Skewer (000-318-CHURRASCO-2), 1
- Rib Hooks (000-318-PRONG), 6
- Duck Hooks (WS-TL-DO-DH), 2
- Chicken Bell Choir (000-318-CBELL-CHOIR), 4
- Skewers (000-318-SKEWER), 4
- Utensil Rack (000-318-UTRACK), 4

## Grate Tool



### Grate Tool

A durable, stainless steel tool with a hook for moving grill grates, the Grate Tool is also useful for manipulating the firebox and wood inside of the charbroiler.

Compatible with all Wood Stone Mt. Saint Helens Charbroilers (Models: WS-SFB-34, 45, 57, 72, 5426).

## Gas-Fired Oven Tool Set



Note: various tool lengths are available. **PLEASE USE THE CHART BELOW TO MATCH YOUR OVEN TO THE RECOMMENDED TOOL LENGTH.**

### Small Gas Oven Tool Set (Pictured)

(1) Utility peel, (1) In-Line brass bristle floor brush, (1) Natural Fiber Brush, (1) T-Style floor brush, (1) bubble hook

### Medium, Long and XLong Gas Oven Tool Set

(1) Utility peel, (1) In-Line Floor brush, (1) Natural Fiber brush, (1) T-style Natural Fiber brush, (1) bubble hook, (1) T-Style brass bristle brush

### Wood Stone Tool Lengths

<u>Tool Description</u>	<u>Short</u>	<u>Medium</u>	<u>Long</u>	<u>X-Long</u>
Natural Fiber Brush (NFB)	36"	51"	70"	87"
In-Line Brass-Bristled Brush (IFB)	40"	60"	70"	87"
T-Style Brass-Bristled Brush (TFB)	40"	60"	70"	87"
T-Style Natural Fiber Brush (TNFB)	40"	60"	70"	87"
Bubble Hook (BH)	40"	60"	70"	87"
Utility Peel (UP)	40"	60"	70"	87"
Utility Peel-Titanium (UP)	40"	60"	70"	87"
Particle Shovel (PS)	40"	60"	70"	87"

What tool lengths does Wood Stone recommend for your oven?

<b>Short</b>	<b>Medium</b>	<b>Long</b>	<b>XLong</b>
Bistro Line 3030	Bistro Line 4355	Mt. Baker 6'	Fire Deck 9690
Bistro Line 4343	Mt. Adams 5'		Fire Deck 11290
Bistro Line 4836	Mt. Chuckanut 4'		Mt. Rainier 7'
	Fire Deck 6045		
	Fire Deck 8645		
	Fire Deck 9660		
	Fire Deck 11260		

## Floor Touch-Up Tool



### Floor Touch-Up Tool

WS-TL-TU

The 67" Floor Touch-Up Tool provides a means to smooth minor surface irregularities on the oven deck, especially when a slightly uneven surface has developed due to a crack in the oven deck.

## Fish and Vegetable Screen



000-305-50

The 26" x 16" Fish and Vegetable screen inserted into the Clamshell Basket compartment expands the versatility of the spit.

## Fire Horse



### **Fire Horse**

The Wood Stone stainless steel Fire Horse can help make your wood fire more efficient. The Fire Horse props up the logs, elevating them off the floor to allow more air to feed the fire.

## Fire Deck Series Ovens



### Fire Deck Series

We make traditional stone hearth Fire Deck ovens in multiple sizes, with cooking or baking surfaces ranging from 7 sq. ft. to 45 sq. ft. Each Deck Oven is available as wood-fired, wood and gas combination ovens, and gas-fired ovens. No matter which size or fuel scenario you prefer, Wood Stone ovens facilitate high volume and throughput.

*\*price dependent on fuel configuration, options, and accessories.*

---

### Available in multiple sizes, fuel configurations and custom finishes:

Fire Deck Series ovens are available in the following sizes:

- FD 6045
- FD 8645
- FD 9660
- FD 11260
- FD 9690
- FD 11275
- FD 11290

Fire Deck Series ovens are available in the following fuel configurations:

- Radiant Flame Gas + Infrared Burner (-RFG-IR)
- Radiant Flame Gas + Infrared Burner + Wood (-RFG-IR-W)
- Radiant Flame Gas + Wood (-RFG-W)
- Wood + Infrared Burner (-W-IR)
- Wood only (-W)

Our Fire Deck series oven are available in a number of custom finishes including custom color powder coat, stucco-ready and facade-ready.

## Extra Long Loading Peel



Note: various tool lengths are available. **PLEASE USE THE CHART BELOW TO MATCH YOUR OVEN TO THE RECOMMENDED TOOL LENGTH.**

### Extra Long Loading Peel

Introducing Wood Stone Loading Peels from Zio Pepe.

These durable, yet lightweight aluminum alloy loading peels come in five sizes that are perfect for up to 12", 14", 16" and 18" pizzas. A 13" loading peel is available in stainless steel.

The short tool set includes only the 12" Loading Peel.

The medium, long, and extra long tool sets include both the 12" and the 16" Loading Peels.

Tool lengths are measured from end to end.

Tool	Part Number	S = Short	M = Medium	L = Long	XL = XLong
Loading Peel 12"	WS-TL-LP-12-(S, M, L, XL)	32"	50"	60"	87"
Loading Peel 14"	WS-TL-LP-14-(S, M, L, XL)	32"	50"	60"	87"
Loading Peel 16"	WS-TL-LP-16-(M, L, XL)	N/A	50"	60"	87"
Loading Peel 18"	WS-TL-LP-18-(M, L, XL)	N/A	50"	60"	87"

What tool lengths does Wood Stone recommend for your oven?

Short	Medium	Long	XLong
Bistro Line 3030	Bistro Line 4355	Mt. Baker 6'	Fire Deck 9690
Bistro Line 4343	Mt. Adams 5'	Fire Deck 11275	Fire Deck 11290
Bistro Line 4836	Fire Deck 6045		Mt. Rainier 7'
Mt. Chuckanut 4'	Fire Deck 8645		
	Fire Deck 9660		
	Fire Deck 11260		

## Coal-Fired Ovens

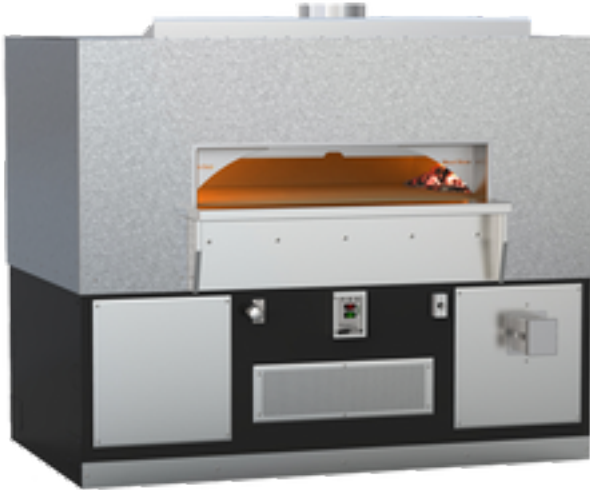

### Coal-Fired Ovens

In 1905, New York City opened its first restaurant to feature a stone hearth oven — the restaurant was *Lombardi's*, and the oven was heated by coal. Engineered with Wood Stone's sophisticated materials, the Coal-Fired Fire Deck provides a unique connection to American history, while keeping up with the production demands of a modern commercial kitchen. With forced-air combustion and a radiant gas flame opposite the coal fire, the Fire Deck has been designed to achieve an excellent balance of top and bottom heat. An underfloor infrared burner assists in maintaining floor temperature and speeding heat-up. A large wide doorway provides spectacular views of the coal fire raging in the chamber, and allows easy access by the operator.

---

#### Available in multiple sizes and custom finishes:

Our Coal-Fired Fire Deck ovens are available in the following sizes:

- FD-9660-CL
- FD-11260-CL
- FD-9690-CL
- FD-11275-CL
- FD-11290-CL

Our Coal-Fired Fire Deck ovens are available in a number of custom finishes including custom color powder coat, stucco-ready and facade-ready.

## Coal Oven Rake



### Coal Oven Rake

Note: various tool lengths are available. **PLEASE USE THE CHART BELOW TO MATCH YOUR OVEN TO THE RECOMMENDED TOOL LENGTH.**

---

WS-TL-CR-M (Medium Handle, 63")

WS-TL-CR-XL (XLong Handle, 84")

<b>Medium</b>	<b>XLong</b>
Fire Deck 9660	Fire Deck 9690
Fire Deck 11260	Fire Deck 11290

## Coal Oven Grates



### **Coal Oven Grates**

RP-GRATE-CL-SET

Two replacement Coal Grates, sold as a set, for Fire Deck Series coal ovens. Both 15.75" x 7.75" grates must be replaced at the same time.

## Clamshell Basket



### Clamshell Basket

000-300

**PLEASE NOTE: Due to the variations in spit lengths, each Clamshell Basket is custom cut to order.**

The versatile Clamshell Basket spit is constructed of heavy gauge stainless steel and conveniently adjusts to hold a variety of products, ranging from fresh vegetables to two entire prime ribs. Stainless steel screens are also available to help secure items (see 000-305-50). Includes Chain Assembly For Clamshell Basket locking mechanism. For use with Wood Stone WS-SFR and WS-GFR models only.

## Churrasco Skewer



### **Churrasco Skewer**

000-318-CHURRASCO-2

The thicker stainless steel Churrasco Skewer for larger proteins and vegetables up to 19.5" in length, including whole fish up to 8 lbs. Will hold 2 roasts up to 12 lbs. each. Prongs are 2". Excellent for table-side presentation. For use with Wood Stone Whatcom Gas Vertical Rotisserie (WS-GVR).

## Chicken TOP Bell Assembly



### Chicken TOP Bell

000-318-TBELL-C

Replacement Chicken Top Bell for cooking chickens on the Whatcom GVR. Includes «S» hook for attachment to the rotisserie and can be used to hang two more standard Chicken Bells to complete a «choir».

## Chicken Bell Choir



### Chicken Bell Choir

000-318-CBELL-CHOIR

A choir of 3 stainless steel «bells» for cooking 3 chickens on the Whatcom Gas Vertical Rotisserie (WS-GVR). Includes one Chicken Top Bell and two standard Chicken Bells.

## Chicken Bell



### Chicken Bell

000-318-BELL

Standard Chicken Bell for cooking chickens on the Whatcom GVR. Must hang below a Top Bell (000-318-TPBELL-C). For use with Wood Stone Whatcom Gas Vertical Rotisserie (WS-GVR).

## Chain Ring Assembly For Clamshell Basket



### Chain Ring Assembly For Clamshell Basket

000-302

Replacement locking mechanism for the Wood Stone Clamshell Basket (item 000-300).

## Bubble Hook



Note: various tool lengths are available. **PLEASE USE THE CHART BELOW TO MATCH YOUR OVEN TO THE RECOMMENDED TOOL LENGTH.**

---

### Bubble Hook

The Bubble Hook is for popping pizza dough bubbles before they get out of hand. Made from heavy gauge stainless steel, it is also great for moving pans, trays and even wood. Available in multiple lengths.

Tool lengths are measured from end to end.

Tool	Part Number	S = Short	M = Medium	L = Long	XL = XLong
Bubble Hook	WS-TL-BH-(S, M, L, XL)	40"	60"	70"	87"

What tool lengths does Wood Stone recommend for your oven?

Short	Medium	Long	XLong
Bistro Line 3030	Bistro Line 4355	Mt. Baker 6'	Fire Deck 9690
Bistro Line 4343	Mt. Adams 5'	Fire Deck 11275	Fire Deck 11290
Bistro Line 4836	Fire Deck 6045		Mt. Rainier 7'
Mt. Chuckanut 4'	Fire Deck 8645		
	Fire Deck 9660		
	Fire Deck 11260		

## Broiler Shelves

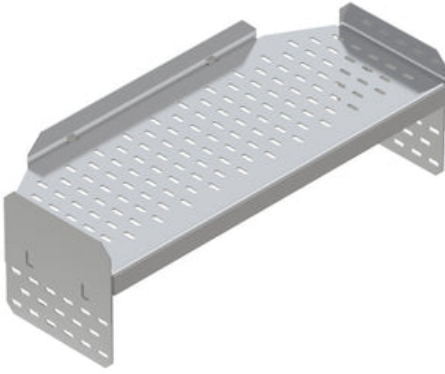

Add another level to your Fire Deck or Mountain Series ovens (5-7')! Wood Stone's new Broiler Shelves are designed to quickly add additional space inside your oven. Position the shelves flush with the back wall and cook food at approximately 100° F temp higher than the floor!

*Currently available for:*

- *MS-5*
- *MS-6*
- *MS-7*
- *FD-6045*
- *FD-8645*
- *FD-9660*
- *FD-11260*

## **Brass Bristled Brush Replacement Heads (2 pk.)**



### **Brass Bristled Brush Replacement Heads (2 pk.)**

Need replacement heads for either your In-Line or T-Style floor brush? We now sell our Brass Bristled Brush Replacement Heads in a convenient 2 pack.

## Bistro Line Ovens

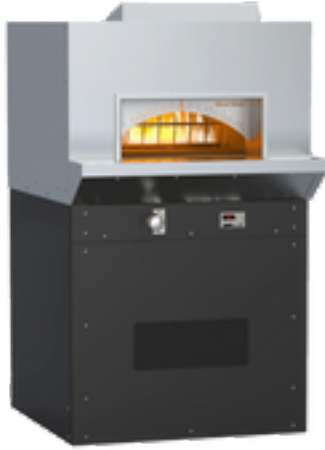

### Bistro Line Ovens

THE COMPACT POWERHOUSE.

The smallest of our stone hearth ovens, the Bistro Line still packs a punch. These ovens are the perfect artisan small pizza ovens for any kitchen. With their compact size and ability to be disassembled to fit through any standard doorway, these small pizza ovens can also fit into almost any cook line!

*\*price dependent on fuel configuration, options, and accessories.*

---

### Available in multiple sizes, fuel configurations and custom finishes:

Bistro Line ovens are available in the following sizes:

- BL 3030
- BL 4343
- BL 4836
- BL 4355

Bistro Line ovens are available in Gas, Wood or Combo fuel configurations. *\*Wood option not available on the Bistro 3030 or 4836*

Our Bistro Line ovens are available in a number of custom finishes including custom color powder coat, stucco-ready and facade-ready.

*Standard finish includes a stainless steel front, sides and back with a black painted stand.*

## Bake Slate



### **Bake Slate**

Baking Slates manufactured from the same ceramic used in the construction of our stone hearth ovens. Available in two sizes (Half: 18"x13") (Full: 18"x26").

## Ash Chute Tool



### **Ash Chute Tool**

WS-TL-ACT-M

The 63" stainless steel Ash Chute Tool is useful for removing ash and small cal fragments from the ash chute on coal-fired ovens.

## Adjustable Basket Retention Rod



### **Adjustable Basket Retention Rod**

000-318-BSKT-ROD

Replacement rod for Large and Small Adjustable Baskets. For use with Wood Stone Whatcom Gas Vertical Rotisserie (WS-GVR).

## 53" Robota Broiler 8x15 Grate



**ATTENTION:** These grates are for the 53" Robota Broiler.

**Confirm your model size before placing the order.**

Replacement 8" x 15" Broiler Grate for the 53" Robota Broiler.

**NO RETURNS ON GRILL GRATES.**

**SHIPPING NOTE:** Grates are very heavy. If ordering more than 4, they will ship 4 per box.

**NOTE:** These grates are NOT compatible with our Jospo Charcoal Broiler Oven or the Mt. St. Helens 5426.

## (Standard) Mt. St. Helens Replacement Broiler Grate



Replacement 6" x 24" Standard Broiler Grate for the 34", 45", 57" and 72" **Mt. St. Helens Solid Fuel Charbroiler**. Please note that two grates on the 72" models are 4" x 24" grates (50RO-0017-1). See table below.

### **NO RETURNS ON GRILL GRATES.**

Thus, please use the table below to select the correct replacement grates for your charbroiler. The number of grates shown represents the number of grates needed to cover the surface of your charbroiler.

**SHIPPING NOTE: Grates are very heavy. If ordering more than 4, they will ship 4 per box.**

**NOTE: These grates are NOT compatible with our Jospo Charcoal Broiler Oven or the Mt. St. Helens 5426.**

MODEL	CHARBROILER WIDTH	6" x 24" GRATES
SFB-34	34"	5
SFB-45	45"	7
SFB-57	57"	9
SFB-72	72"	10 (+2 ea. 4" x 24")

## (Custom) Mt. St. Helens Replacement Broiler Grate Narrow



**ATTENTION:** These grates are for the **NARROW SFB-72"** Charbroiler. Confirm your model size before placing the order. For **STANDARD SFB** replacement grates, please select item: «(Standard) Mt. St. Helens Replacement Broiler Grate.»

Replacement 4" x 24" Broiler Grate Narrow for the 72" **Mt. St. Helens Solid Fuel Charbroiler**. Please note that the other 10 grates on the 72" models are 6" x 24" (50RO-0017) grates. See table below.

**NO RETURNS ON GRILL GRATES.**

Thus, please use the table below to select the correct replacement grates for your charbroiler. The number of grates shown represents the number of grates needed to fulfill the complete set for the SFB 72 model.

**SHIPPING NOTE:** Grates are very heavy. If ordering more than 4, they will ship 4 per box.

**NOTE:** These grates are **NOT** compatible with our Jospo Charcoal Broiler Oven or the Mt. St. Helens 5426.

MODEL	WIDTH	4" x 24" GRATES
SFB-72	72"	2 (+ 10 ea. 6" x 24")

## "Start-Up Oven Package"



### Introducing our new Mountain Series «Start-Up Package!»

Our famous WS-MS-RFG stone hearth oven is *perfect* for casual dining, bars & pubs and now comes packaged with all the bells and whistles to provide all the firepower and versatility you need in a single piece of equipment.

With a Mountain Series Start Up Package, you'll receive:

- Upper lagging in the powder coat color of your choice.
- Custom branded flame guard — *put your name on the flame!*
- Our *new* Debris Mantle, making clean up a breeze.
- A stainless steel stand wrap.
- Medium tool set.

## По вопросам продаж и поддержки обращайтесь:

Алматы (727)345-47-04  
Ангарск (3955)60-70-56  
Архангельск (8182)63-90-72  
Астрахань (8512)99-46-04  
Барнаул (3852)73-04-60  
Белгород (4722)40-23-64  
Благовещенск (4162)22-76-07  
Брянск (4832)59-03-52  
Владивосток (423)249-28-31  
Владикавказ (8672)28-90-48  
Владимир (4922)49-43-18  
Волгоград (844)278-03-48  
Вологда (8172)26-41-59  
Воронеж (473)204-51-73  
Екатеринбург (343)384-55-89

Иваново (4932)77-34-06  
Ижевск (3412)26-03-58  
Иркутск (395)279-98-46  
Казань (843)206-01-48  
Калининград (4012)72-03-81  
Калуга (4842)92-23-67  
Кемерово (3842)65-04-62  
Киров (8332)68-02-04  
Коломна (4966)23-41-49  
Кострома (4942)77-07-48  
Краснодар (861)203-40-90  
Красноярск (391)204-63-61  
Курск (4712)77-13-04  
Курган (3522)50-90-47  
Липецк (4742)52-20-81

Магнитогорск (3519)55-03-13  
Москва (495)268-04-70  
Мурманск (8152)59-64-93  
Набережные Челны (8552)20-53-41  
Нижний Новгород (831)429-08-12  
Новокузнецк (3843)20-46-81  
Ноябрьск (3496)41-32-12  
Новосибирск (383)227-86-73  
Омск (3812)21-46-40  
Орел (4862)44-53-42  
Оренбург (3532)37-68-04  
Пенза (8412)22-31-16  
Петрозаводск (8142)55-98-37  
Псков (8112)59-10-37  
Пермь (342)205-81-47

Ростов-на-Дону (863)308-18-15  
Рязань (4912)46-61-64  
Самара (846)206-03-16  
Санкт-Петербург (812)309-46-40  
Саратов (845)249-38-78  
Севастополь (8692)22-31-93  
Саранск (8342)22-96-24  
Симферополь (3652)67-13-56  
Смоленск (4812)29-41-54  
Сочи (862)225-72-31  
Ставрополь (8652)20-65-13  
Сургут (3462)77-98-35  
Сыктывкар (8212)25-95-17  
Тамбов (4752)50-40-97  
Тверь (4822)63-31-35

Тольятти (8482)63-91-07  
Томск (3822)98-41-53  
Тула (4872)33-79-87  
Тюмень (3452)66-21-18  
Ульяновск (8422)24-23-59  
Улан-Удэ (3012)59-97-51  
Уфа (347)229-48-12  
Хабаровск (4212)92-98-04  
Чебоксары (8352)28-53-07  
Челябинск (351)202-03-61  
Череповец (8202)49-02-64  
Чита (3022)38-34-83  
Якутск (4112)23-90-97  
Ярославль (4852)69-52-93

**Россия** +7(495)268-04-70

**Казахстан** +7(727)345-47-04

**Беларусь** +(375)257-127-884

**Узбекистан** +998(71)205-18-59

**Киргизия** +996(312)96-26-47

эл.почта: [wes@nt-rt.ru](mailto:wes@nt-rt.ru) || сайт: <https://wood-stone.nt-rt.ru/>